



BOSCH

Percussion Drill

TSB 5500 | 3 601 AA1 082

Table of Content

Spare parts list.....	2
Illustration - Type.....	3

Spare parts list

Item	Part Number	Description
1	1 619 PB4 746	Housing
2	1 619 PA0 678	Field 220-240V
4	1 619 PA0 679	On-Off Switch
5	1 619 PA8 071	Power supply cord
6	1 619 PB2 058	Grommet Ø 9 mm
12	1 619 PA0 702	Suppression Capacitor
13	1 619 PA0 681	groove ball bearing
14	1 619 PA0 680	groove ball bearing
16	1 619 PA1 407	Carbon-Brush Set
19	1 619 PA0 683	Torx Oval-Head Screw
25	1 619 PA0 684	Lever
31	1 619 PA0 701	Change-Over Switch
32	F 000 615 033	Ball
34	1 619 PA0 685	Bearing Bracket
41	1 619 PA6 599	Cable
43	1 619 PA0 703	Suppressor Box
56	1 619 PA0 690	Woodruff Key
70	F 000 616 083	Tapping Screw
71	F 000 616 084	Fastening Clamp
803	1 619 PA0 697	Armature 220-240V
836	1 619 PA1 858	Drilling Spindle
839	1 619 PA1 689	Key Chuck
839/7	1 619 PA0 694	Chuck Wrench
651	1 619 PB4 323	Auxiliary Handle
698	2 603 001 009	Depth-Gauge

Illustration - Type - E

3 601 AA1 080
 Stand } 19-10-11
 Issue } 19-10-16

Fig. /Abb. 1

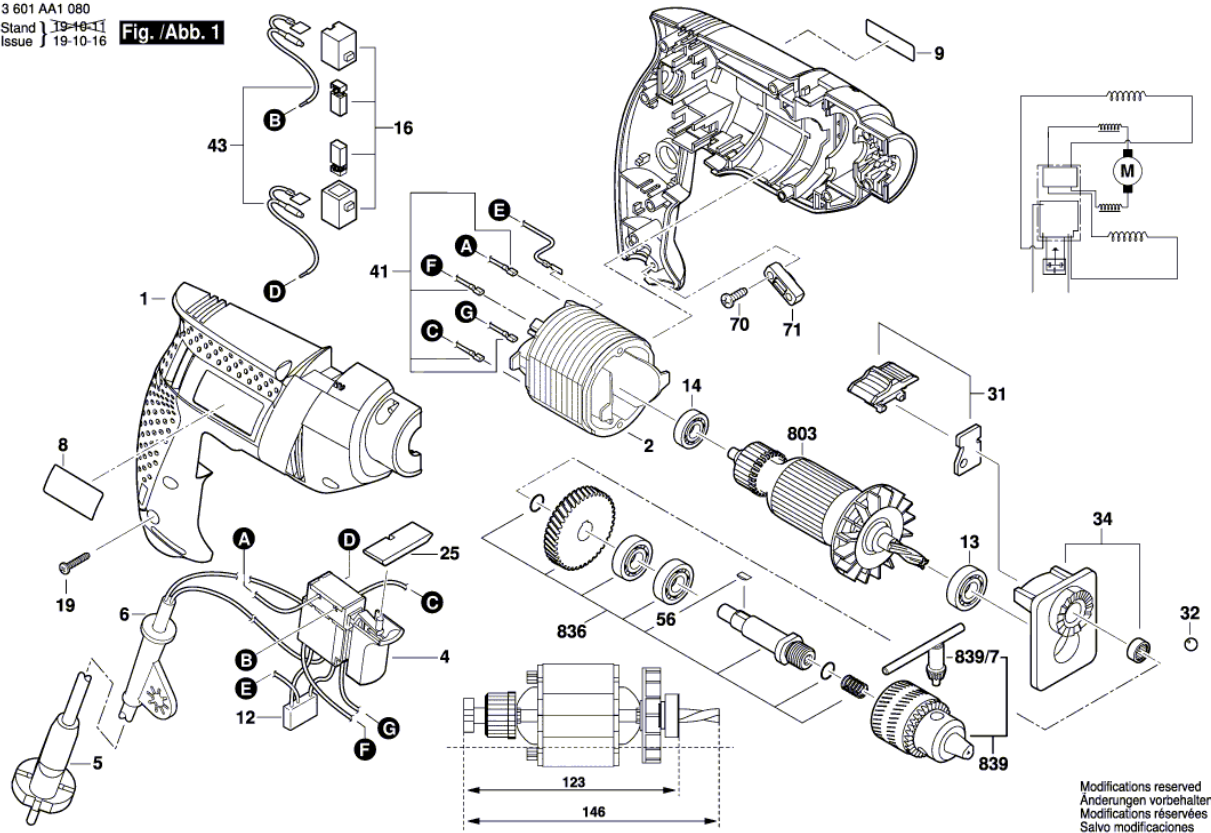
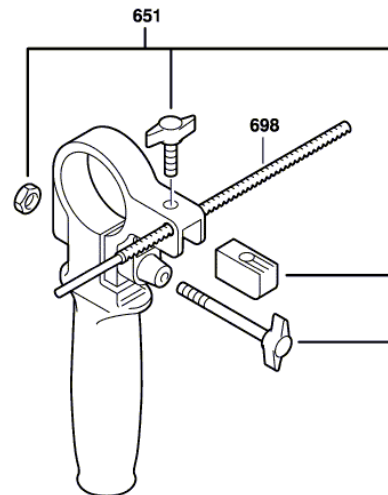

Illustration - Type - E

3 601 AA1 080
Stand } 10-12-07 **Fig. /Abb. 2**
Issue }



Modifications reserved
Änderungen vorbehalten
Modifications réservées
Salvo modificaciones