

# F Saw Attachment

compl 537 18 33-11  
compl 537 18 33-12 (USA)

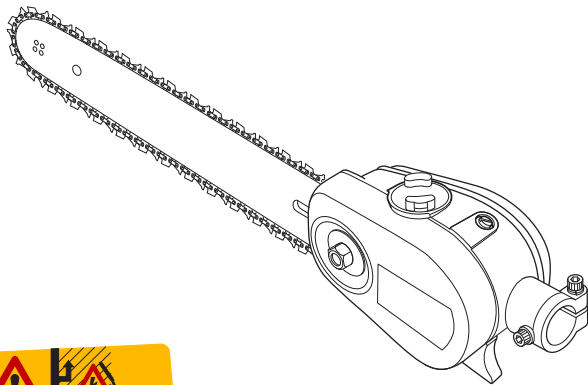

537 38 89-01\*

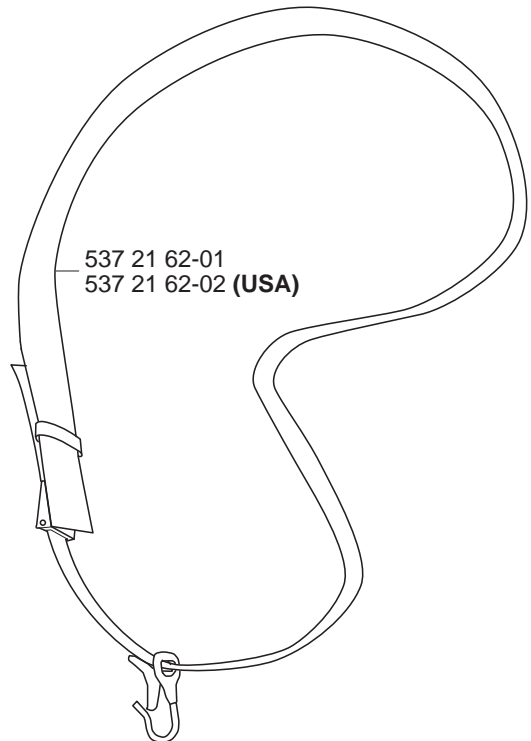

537 21 62-01  
537 21 62-02 (USA)

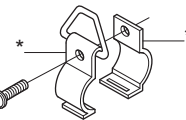

\*compl 501 78 33-01

\*503 21 83-16

# F Saw Attachment L=110mm

compl 537 18 33-13

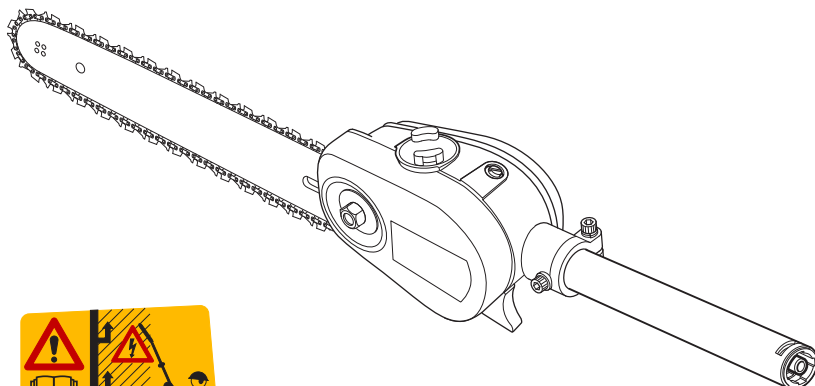

537 38 89-01\*

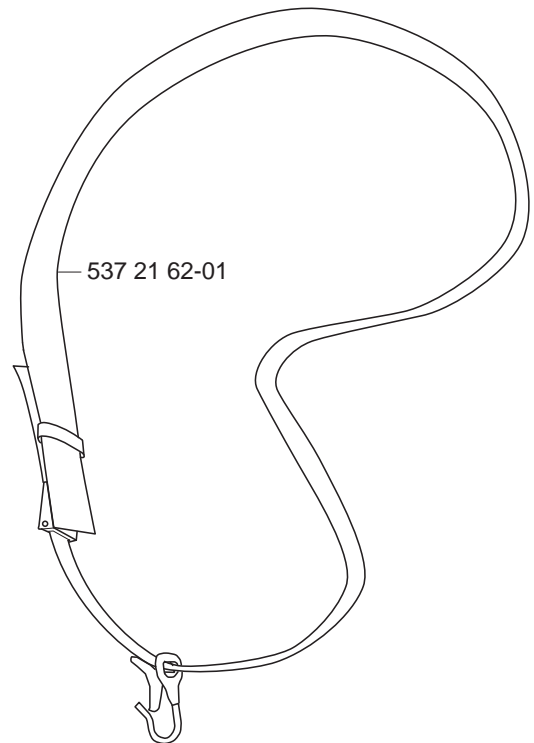

537 21 62-01

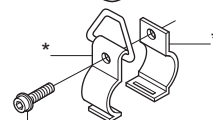

\*compl 501 78 33-01

503 21 83-16\*

# F Saw Attachment L=1100mm

compl 537 18 33-16

compl 537 18 33-17 (USA)

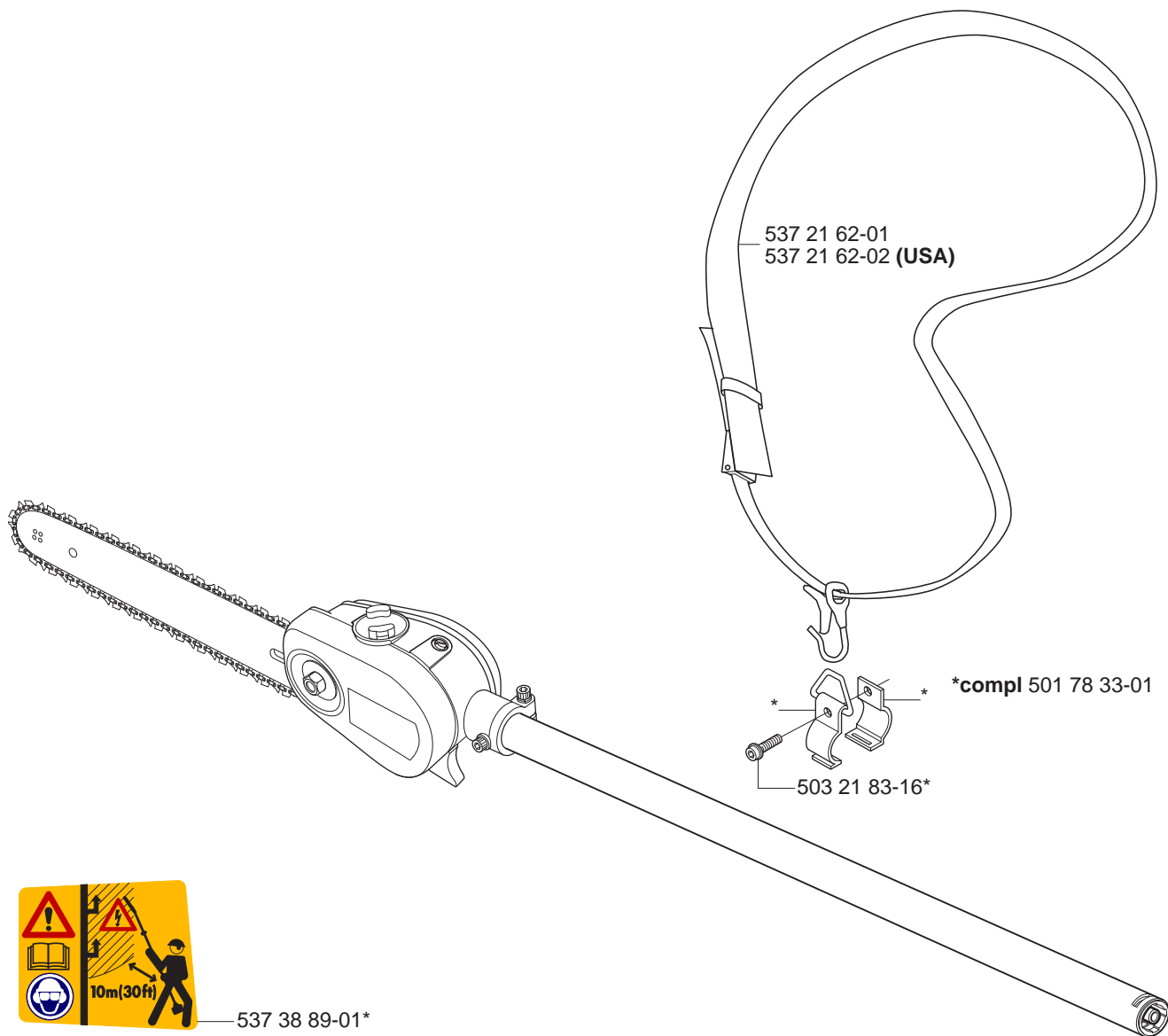

# G Saw Attachment

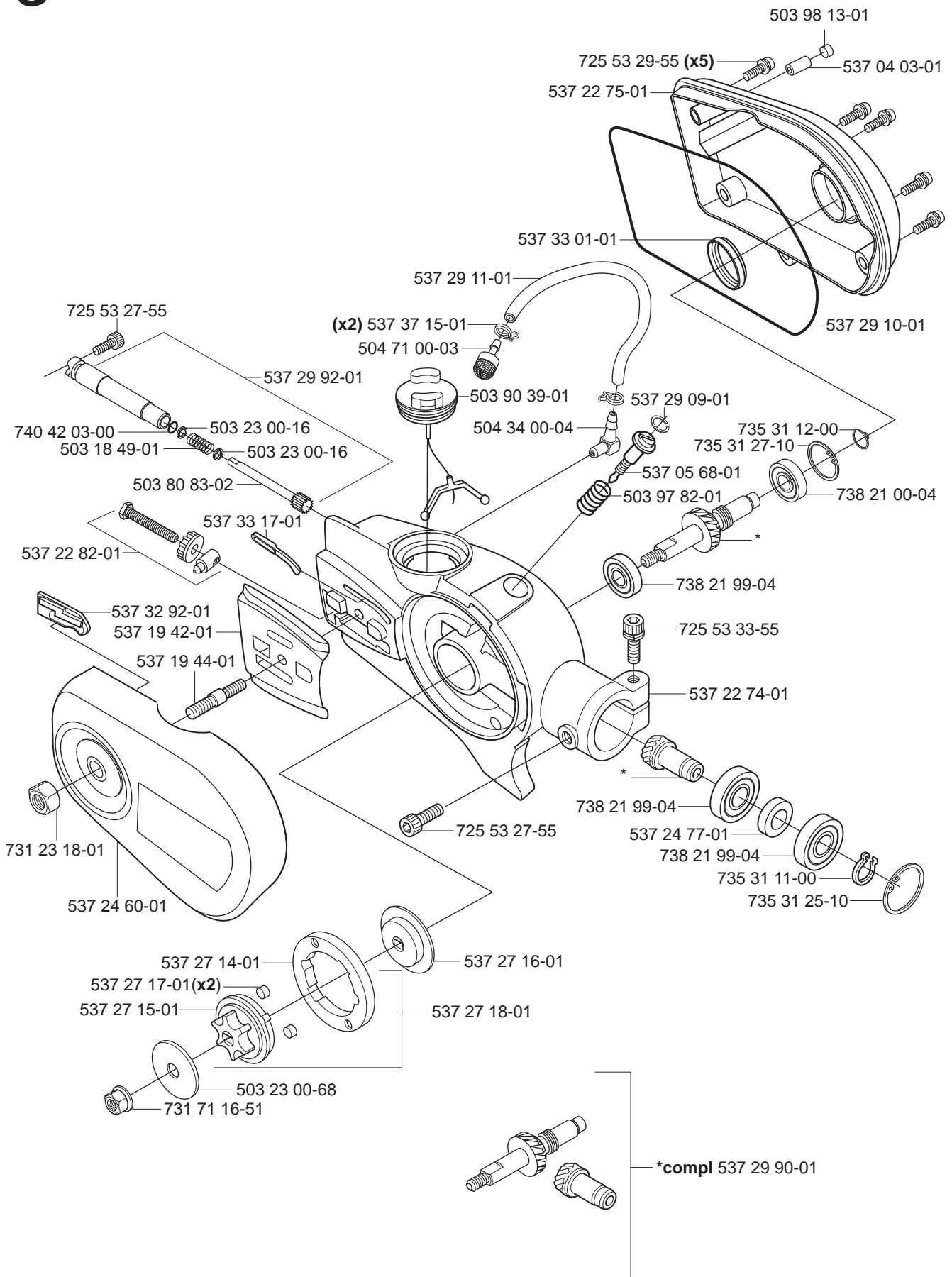

537 23 00-01



