

Circular saw - F 012 SD7 721 - SHD77

Item	Part Number	Description	Illustration	Price	Quantity	Price Group
2	1 619 P08 113	Field 120V	1	-,-	1	-
3	1 619 P08 013	Armature 120V	1	-,-	1	-
4	1 619 X08 653	Switch	1	-,-	1	27
5	1 619 X08 584	Power supply cord	1	-,-	1	-
6	1 619 X08 308	Grommet	1	-,-	1	-
7	1 619 X04 671	Cable Clip	1	-,-	1	-
9	1 619 X08 871	Manufacturer's nameplate SHD 77	1	-,-	1	-
13	2 610 017 348	Deep-Groove Ball Bearing	1	-,-	1	23
14	2 610 024 748	Ball Bearing	1	-,-	1	22
18	2 610 901 971	Screw	1	-,-	1	10
20	1 619 X04 679	Warning Plate	1	-,-	1	-
22	1 619 X06 255	Hood	1	-,-	1	-
23	1 619 X01 249	Washer	1	-,-	1	18
24	1 619 X04 683	Washer	1	-,-	1	-
25	1 619 X04 684	Oil Drain Plug	1	-,-	1	-
25/4	1 616 B10 364	O-Ring	1	-,-	1	-
26	1 619 X03 643	Collar bolt	1	-,-	1	-
27	1 619 X01 262	Stud	1	-,-	1	-
28	1 619 X04 693	Lower guard	1	-,-	1	-
31	2 610 017 875	Ball Bearing	1	-,-	1	20
33	1 619 X04 765	Extension Spring	1	-,-	1	-
35	2 610 319 494	End stop	1	-,-	1	12
36	2 610 341 359	Spring retaining ring	1	-,-	1	12
38	1 619 X06 248	Upper guard	1	-,-	1	-
39	1 619 X07 688	Lever	1	-,-	1	-
40	1 619 X06 247	Handle	1	-,-	1	-
42	1 619 X01 253	Bearing Plate	1	-,-	1	-
43	1 619 X01 255	Guard Plate	1	-,-	1	-
45	1 619 X01 228	Cover	1	-,-	1	-
46	1 619 X01 268	Device cap	1	-,-	2	10
47	1 619 X04 712	O-Ring	1	-,-	1	-
48	1 619 X04 780	Collar	1	-,-	1	-
50	1 619 X04 708	Brush Holder	1	-,-	2	-

Item	Part Number	Description	Illustration	Price	Quantity	Price Group
51	2 610 004 341	Washer	1	-,-	1	11
52	2 610 912 616	Washer	1	-,-	2	10
53	2 610 968 747	Spring retaining ring	1	-,-	2	10
54	1 619 X04 719	Locking Lever	1	-,-	2	-
55	1 619 X04 676	Ball Bearing	1	-,-	1	-
56	2 610 027 039	Set screw	1	-,-	2	-
57	2 610 315 299	Screw	1	-,-	2	11
58	2 610 315 380	Screw	1	-,-	4	11
59	1 619 X03 644	Screw	1	-,-	1	-
60	1 619 X06 222	O-Ring	1	-,-	1	-
62	1 619 X03 110	Washer	1	-,-	1	10
63	2 610 329 955	Screw	1	-,-	3	11
64	1 619 X01 786	Contact Screw	1	-,-	4	10
65	2 610 306 355	Washer	1	-,-	3	11
66	1 619 X01 263	Stud	1	-,-	1	-
67	1 619 X04 687	O-Ring	1	-,-	1	-
68	2 610 932 332	Screw	1	-,-	3	-
69	2 610 932 460	Self-locking nut	1	-,-	1	10
71	2 610 027 002	Screw	1	-,-	5	11
72	2 610 016 325	Bolt	1	-,-	1	10
73	2 610 004 459	Spring Washer	1	-,-	2	11
74	1 619 X01 257	Rubber Gasket	1	-,-	1	-
75	1 619 X07 731	Seal	1	-,-	1	-
78	1 619 X04 740	Seal	1	-,-	1	-
79	1 619 X04 738	Screw	1	-,-	4	-
80	1 619 X06 749	Screw	1	-,-	1	10
81	2 610 329 950	Screw	1	-,-	2	11
82	1 619 X01 258	Gasket	1	-,-	1	-
83	1 619 X06 283	Set Of Handles	1	-,-	1	-
84	2 610 318 324	Nut	1	-,-	1	11
85	1 619 X06 294	Screw	1	-,-	1	-
86	1 619 X04 746	Screw	1	-,-	4	-
87	1 619 X06 242	Bushing	1	-,-	1	-
88	1 619 X06 254	Washer	1	-,-	1	-
90	1 619 X01 260	Bearing Cover	1	-,-	1	-
91	1 619 X06 749	Screw	1	-,-	1	10
92	2 610 932 218	Screw	1	-,-	1	11
93	1 619 X01 283	Nut	1	-,-	2	14
105	1 619 X03 501	Washer	1	-,-	1	10
107	1 619 X07 186	Screw	1	-,-	1	-
119	1 619 X06 256	Spring	1	-,-	1	-
120	1 619 X06 257	Screw	1	-,-	1	-
122	1 619 X05 847	Washer	1	-,-	1	-
651	1 619 X04 755	Socket wrench	1	-,-	1	-
801	1 619 X07 036	Motor Housing	1	-,-	1	-
808	1 619 X06 304	Nameplate	1	-,-	1	-
810	1 619 X08 020	Carbon-Brush Set	1	-,-	1	-
819	1 619 X06 258	Base Plate	1	-,-	1	-
821	1 619 X06 241	Gear Housing	1	-,-	1	-
834	1 619 X07 035	Set Of Gears	1	-,-	1	-
867	1 619 X09 014	Deep-Groove Ball Bearing	1	-,-	1	-

Illustration - Type E

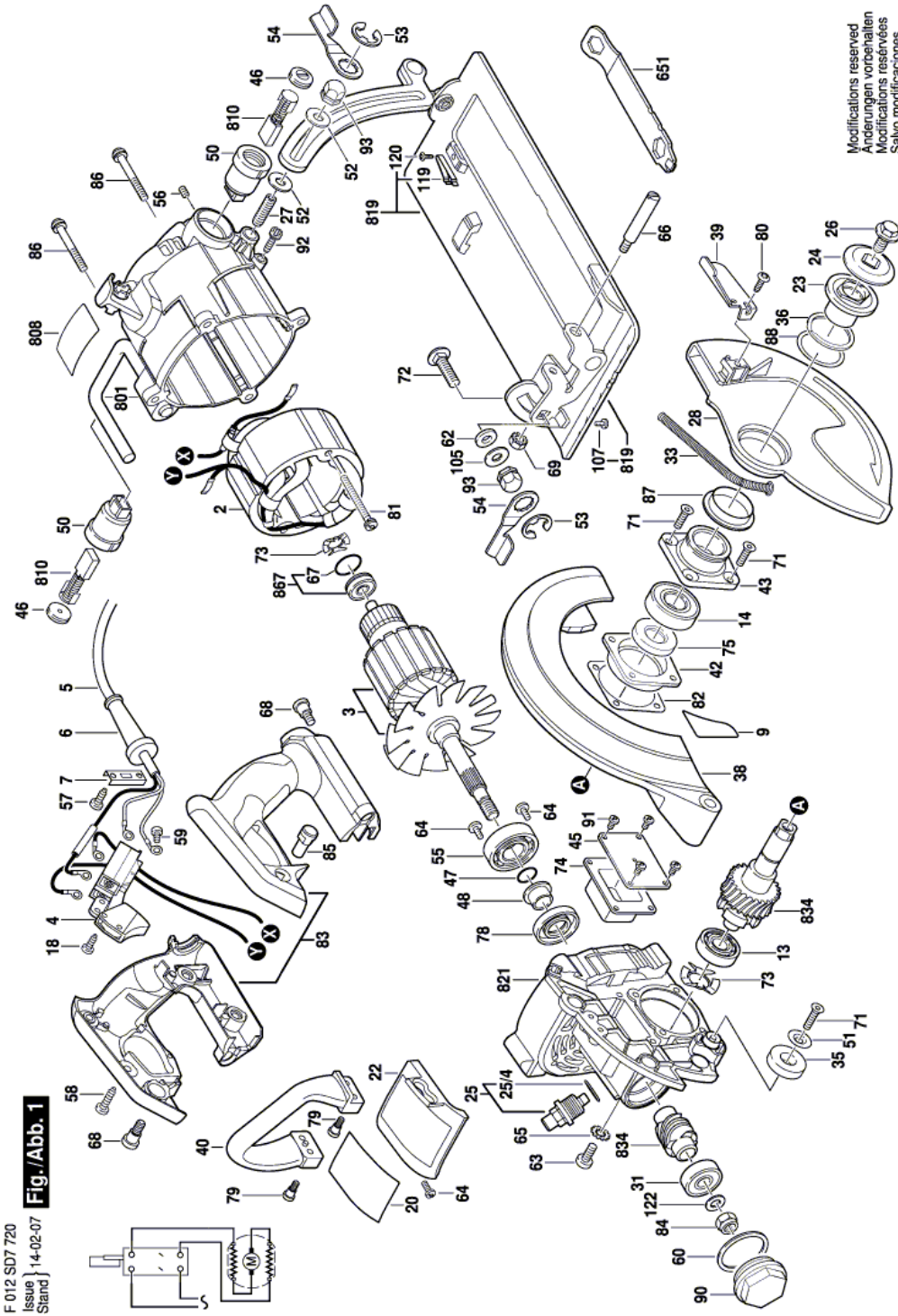

Modifications reserved
Änderungen vorbehalten
Modificacions reservées
Salvo modificaciones

F 012 SD7 720
Issue 14-02-07
Stand
Fig./Abb. 1

Information subject to change without further notice.