

MODEL : K15S-30UMS

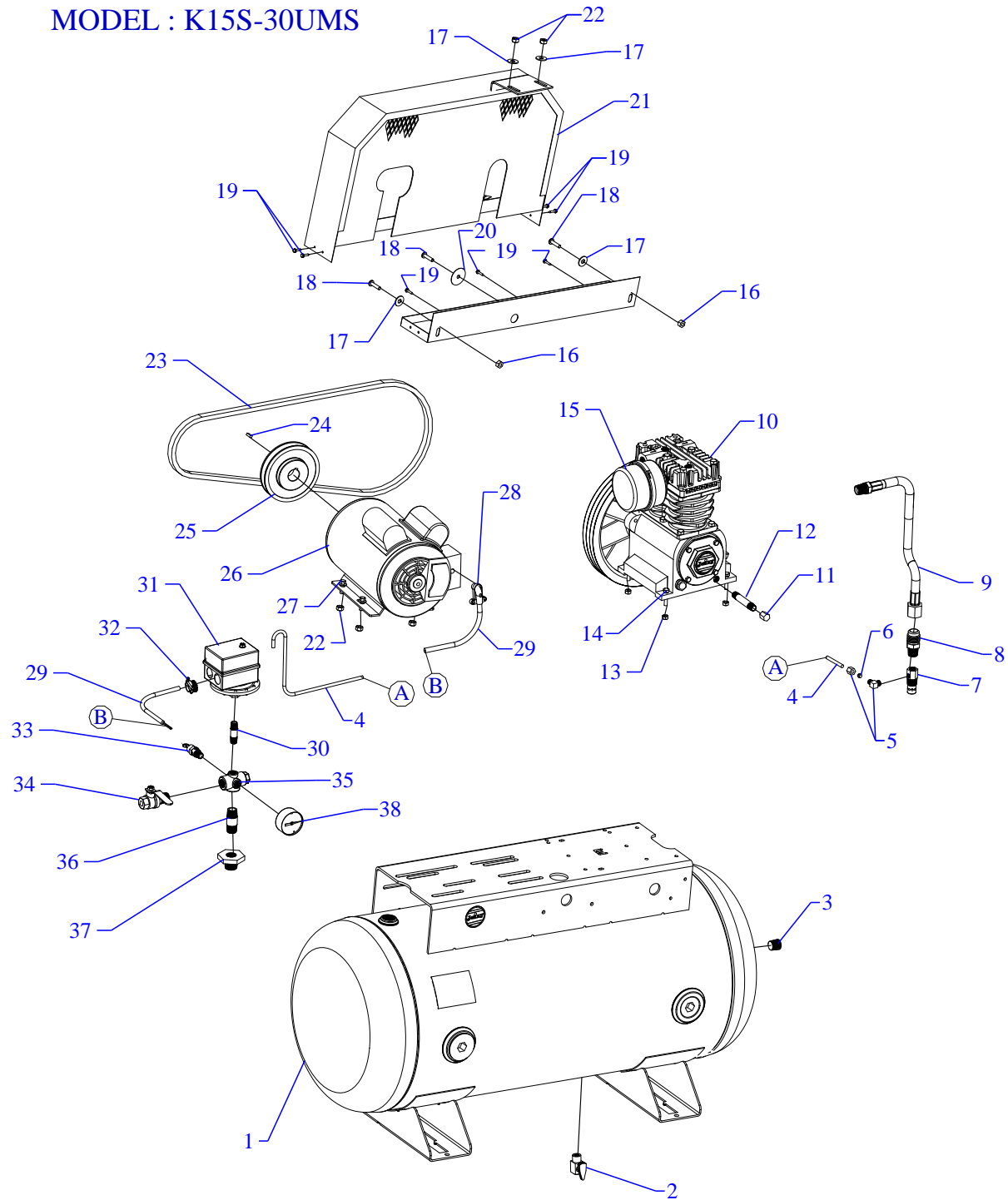

Parts List for Model K15S-30 Single Phase

NOTE: The quantity number indicates the total number of pieces required for a complete unit repair.
When ordering parts give compressor model, serial number and part number. Order assemblies when possible.

<u>REF. NO.</u>	<u>PART NO.</u>	<u>DESCRIPTION</u>	<u>QTY.</u>
1	411-1048	TANK,HRZNTL,30G,UM,F&K&GE,H30UM-1	1
2	141-1077	VALVE,BALL,LEVER,1/4 TURN,1/4" M X 1/4" F	1
3	122-1047	PLUG,SOCKET,HEX,ST,PLTD,1/2" NPT	1
4	610-1090	TUBE,CONTROL,COPPER,W/SLEEVE,1/4"X39"LG	1
5	121-1032	ELBOW,MALE,COMPRESSION,BR,1/4TBX1/8"NPTM	1
6	121-1080	SLEEVE,COMPRESSION,BRASS,1/4"	1
7	141-1034	VALVE,CHECK,INSERT,1/2" M X 3/8" F,W/1/8" PT	1
8	121-1005	CONNECTOR,MALE,BRASS,1/2-45SAEX3/8"NPTM	1
9	360-1390	AFTERCOOLER,HOSE,SS,TEFLON,5/8"ODX16-1/2	1
10	421-1101	PUMP,CMPRSR,PISTON,REPLCMT,BLUE,K	1
11	122-1126	CAP,HEX,MI,PLATED,1/4"NPT	1
12	122-1034	NIPPLE,STEEL,SCH 40,1/4" X 5" L	1
13	120-1116	NUT,LOCK,FLANGE,HEX,SERR,ST,PLTD,1/4-20	4
14	120-1220	SCREW,CAP,HEXHD,GR5,ST,PLD,1/4-20X1-3/4	4
15	320-1121	FILTER,W/DECALS,ASSY,G154S	1
16	120-1116	NUT,LOCK,FLANGE,HEX,SERR,ST,PLTD,1/4-20	2
17	120-1075	WASHER,FLAT,STEEL,PLATED,5/16"	4
18	120-1267	SCREW,PAN HD,PHIL,STEEL,PLTD,1/4-20 X 1"	3
19	120-1177	SCREW,SELF DRILL,HEX,ST,PL,12 X 3/4	7
20	120-1072	WASHER,FENDER,ST,PLATED,1/4"X1-1/2"OD	1
21	320-1177	BELTGUARD,F&K,W/PAN,3.4WX13.0HX23LG	1
22	120-1119	NUT,LOCK,FLANGE,HEX,SERR,ST,PLTD,5/16-18	6
23	154-4L490	BELT,VEE,A43,4L-490	1

Parts List for Model K15S-30 Single Phase

NOTE: The quantity number indicates the total number of pieces required for a complete unit repair.
When ordering parts give compressor model, serial number and part number. Order assemblies when possible.

<u>REF. NO.</u>	<u>PART NO.</u>	<u>DESCRIPTION</u>	<u>QTY.</u>
24	120-1108	KEY,STEEL,BLACK,3/16X3/16X 1-1/2" LENGTH	1
25	154-1212	PULLEY,CI,SG,6.2PDA,5/8ID,AK66X5/8	1
26	130-1015	MOTOR,1.5HP,115-208-230/60/1,1725RPM,ODP	1
27	120-1018	SCREW,FLANGE,HEX,SERR,ST,PLD,5/16-18X3/4	4
28	123-1032	CONNECTOR,CABLE,BX,90 DEG,3/8"	1
29	123-1003	WIRE,ASSY,BX,14/2,WITH GROUND	2FT
30	122-1137	NIPPLE,CLOSE,STEEL,SCH 40,PLATED,1/4"	1
31	140-1079	SWITCH,PSI,2HP,30-40#,UNLOADER,PAV 14-60	1
32	123-1029	CONNECTOR,ROMEX,CLAMP,STRAIGHT,3/8"	1
33	141-1018	VALVE,SAFETY,ASME,1/4",65 PSI,SVU65	1
34	141-1078	VALVE,BALL,OUTLET,1/4 TURN,1/2"M X 1/2"F	1
35	220-1059	BLOCK,MANIFOLD,AL,5 PORT,SPRINKLER,MC-5S	1
36	122-1088	NIPPLE,STEEL,SCH 80,PLATED,1/2" X 2"	1
37	122-1206	BUSHING,REDUCER,HEX,ST,PLTD,3/4" X 1/2"N	1
38	142-1000	GAUGE,PSI,200#,BK MT,JENNY,2",1/4NPT,PG2	1
NOT SHOWN	610-1225	KIT,ELEMENT,FILTER,G54E,PKG OF 4,G54EP	1
NOT SHOWN	105-1209	OIL,PUMP,SYNTHETIC,BLUE,1 QUART,ESQ	1

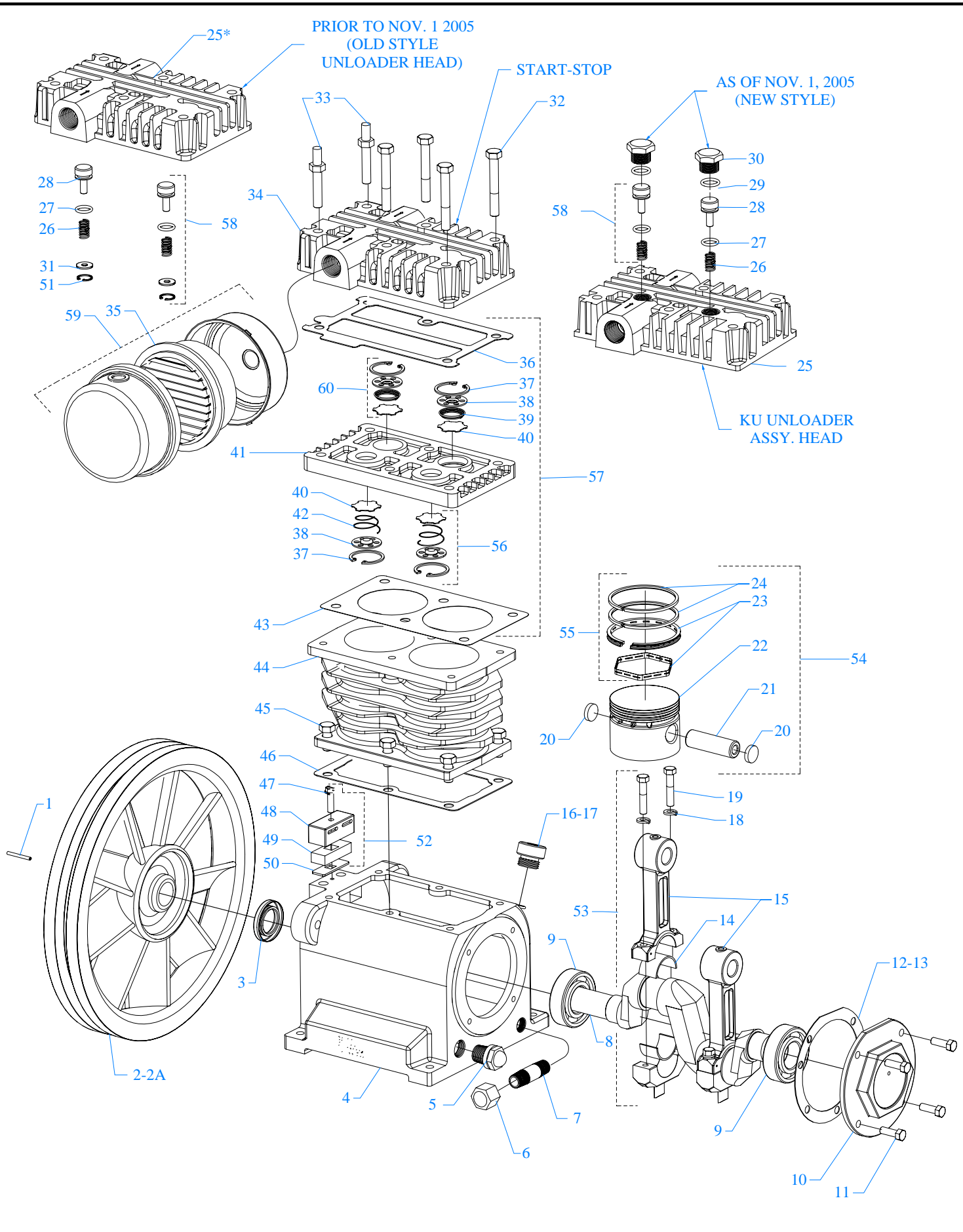

MODEL K & KU
 Two Cylinder Single Stage
 2-1/2" Bore X 2" Stroke

Parts List for Model K & KU Pump Assembly

NOTE: The quantity number indicates the total number of pieces required for a complete unit repair.
When ordering parts give compressor model, serial number and part number. Order assemblies when possible.

<u>REF. NO.</u>	<u>PART NO.</u>	<u>DESCRIPTION</u>	<u>QTY.</u>
1	120-1163	PIN,ROLLED,COILED,STL,BLK,1/4ODX1L,K25	1
2	220-1093	FLYWHEEL,K PUMP,CI,10-3/8,1 GROOVE,K23A	1
2A	220-1090	FLYWHEEL,GT PUMP,CI,13-1/4,2 GROOVE,G23 (KC Pump)	1
3	150-1036	SEAL,OIL,LIP,SINGLE,0.875 DIA,K11E	1
4	220-1009	CRANKCASE,K PUMP,CI,W/SIGHT GLASS,K1	1
5	160-1076	GAUGE,SIGHT,LEVEL,OIL,3/8"NPT,LO-M49	1
6	122-1083	CAP,HEX,MI,1/4"NPT	1
7	122-1032	NIPPLE,STEEL,SCH 40,1/4" X 3" L	1
8	220-1010	CRANKSHAFT,K PUMP,CI,MACHINED,K20A	1
9	150-1000	BEARING,BALL,K9	2
10	220-1001	CAP,BEARING,K PUMP,CI,MACHINED,K2	1
11	120-1004	SCREW,CAP,HEXHD,GR5,ST,BLK,1/4-20X3/4 (10FT-LB)	4
12	104-1000-01	GASKET,CAP,BEARING,F&K&G PUMP,1/32THK,L3	1
13	104-1000-02	GASKET,CAP,BEARING,F&K&G PUMP,1/64THK,L4	1
14	150-1011	BEARING,ROD,CONNECTING,PUMP,F,K,G	4
15	310-1001-02	ROD,CONNECTING,WO/BRNG INSERT,L21L&L21K	2
16	610-1029	PLUG,CRANKCASE,FILL,OIL,W/O-RING,K14	1
17	104-1016	RING,O,BUNA-N,5/8"IDX13/16"ODX3/32"THK	1
18	120-1068	WASHER,LOCK,SPLIT,ST,BLK,HIGH CLLR,1/4"	4
19	120-1010	SCREW,CAP,HEXHD,GR5,ST,BLK,1/4-20X1-1/4 10 FT-LB	4
20	104-1103	BUMPER,WRIST PIN,PLASTIC,K36A	4
21	150-1005	PIN,PISTON,STEEL,HARDENED,K35	2
22	220-1005	PISTON,PUMP,ALUMINUM,MACHINED,K32	2

Parts List for Model K & KU Pump Assembly

NOTE: The quantity number indicates the total number of pieces required for a complete unit repair.
When ordering parts give compressor model, serial number and part number. Order assemblies when possible.

<u>REF. NO.</u>	<u>PART NO.</u>	<u>DESCRIPTION</u>	<u>QTY.</u>
23	610-1065	KIT,RING,OIL,W/EXPANDER,ASSY,K34	2
24	150-1003	RING,COMPRESSION,PISTON,STEEL,EBA 22,K33	4
25	220-1016	HEAD,UNLOADING,G PUMP,CI,6HOLES,LU80	1
26	150-1020	SPRING,VALVE,UNLOADER,INTAKE, KU83	2
27	104-1020	RING,O,SILICON,7/16"IDX5/8"ODX3/32"THK	2
28	150-1028	PISTON,UNLOADER,VALVE,BRASS,KU81	2
29	104-1015	RING,O,BUNA-N,1/2"IDX11/16"ODX3/32"THK	2
30	122-1051	PLUG,HEX ,BRASS,11/16-16 UN-2B X .550	2
31	150-1042	WASHER,BRASS,1/32X 0.605ODX1/4 ID,KU84	2
32	120-1028	SCREW,CAP,HEXHD,GR5,ST,BLK,5/16-18X2-1/4 (22 FT-LB)	4
33	120-1252	BOLT,STUD,HEX,ST,5/16-18X2-1/4X5/8,K52-1 (22 FT-LB)	2
34	310-1004	HEAD,START/STOP,G PUMP,REPLACEMNT,L50	1
35	150-1104	ELEMENT,FILTER,AIR,COMPRESSOR,JENNY,G54E	1
36	104-1008	GASKET,HEAD,K&G&W PUMP,1/32THK,L51	1
37	150-1041	RETAINER,VALVE,STEEL,PAS,0.062"THK,K43	4
38	109-1010	VALVE,BUMPER,STEEL,K44	4
39	150-1018	SPRING,CONE,SS,VALVE,DISCHARGE,K46	2
40	109-1011	VALVE,DISC,STAINLESS STEEL,K47	4
41	220-1013	PLATE,VALVE,L PUMP,CI,MACHINED,L40	1
42	150-1017	SPRING,CONE,SS,VALVE,INTAKE,K45	2
43	104-1007	GASKET,PLATE,VALVE,K&G&W PUMP,1/32TK,L41	1
44	360-1150	CYLINDER,K PUMP,CI,PAINTED,BLUE,K30	1
45	120-1017	SCREW,CAP,HEXHD,GR5,ST,BLK,5/16-18X3/4 (15FT-LB)	6

Parts List for Model K & KU Pump Assembly

NOTE: The quantity number indicates the total number of pieces required for a complete unit repair.
When ordering parts give compressor model, serial number and part number. Order assemblies when possible.

<u>REF. NO.</u>	<u>PART NO.</u>	<u>DESCRIPTION</u>	<u>QTY.</u>
46	104-1006	GASKET,CYLINDER,K&G&W PUMP,1/32THK,K31	1
47	132776	SCREW,MACH,RND HD,SLTD,ST,PL,#8-32X1"	1
48	104-1264	RETAINER,BREATHER,CRANKCASE,PLASTIC,BLUE	1
49	104-1265	FILTER,AIR,BREATHER,CRANKCASE,INSERT	1
50	104-1266	SEAL,BREATHER,CRANKCASE,FILTERED,RUBBER	1
51	120-1167	RETAINER,INTERNAL,ST,0.035X 0.665,KU85	2
Assemblies			
52	610-1410	BREATHER,CRANKCASE,W/HOUSING&FILTER&SEAL Includes 47, 48, 49, 50	1
53	610-1411	ROD,CONNECTING,W/BEARNG INSERT,L21L&L21K INCLUDES 14(2), 15, 18(2), 19(2)	2
54	610-1028	PISTON,W/RINGS&PIN,ASSY,K132 INCLUDES 20 (2), 21, 22, 23, 24 (2)	2
55	610-1020	KIT,PUMP,RING,PISTON,F&K&G&W PUMP,K133 INCLUDES 23 (2), 24 (4)	1
56	610-1031	VALVE,SUCTION,ASSY,K145 INCLUDES 37, 38, 40, 42	2
57	610-1045	PLATE,VALVE,W/VALVES,ASSY,L140 INCLUDES 36, 41, 43, 56(2), 60(2)	1
58	610-1042	VALVE,UNLOADER,HEAD,PUMP,ASSY,KU181 INCLUDES 26, 27, 28, 31, 51	2
59	320-1121	FILTER,W/DECALS,ASSY,G154S	1
60	610-1032	VALVE,DISCHARGE,ASSY,K146 INCLUDES 37, 38, 39, 40	2
61	610-1026	KIT,GASKET,K PUMP,ASSY,K100A INCLUDES 12,13,36,43,46	1
NOT SHOWN	610-1123	KIT,BASIC,REPAIR,KU PUMP,K101 W/G54E INCLUDES 35, 52, 55, 56(2), 60(2), 61	1
NOT SHOWN	610-1304	KIT,BASIC,REPAIR,KU PUMP,W/G54E,KU101G	1

Parts List for Model K & KU Pump Assembly

NOTE: The quantity number indicates the total number of pieces required for a complete unit repair.
When ordering parts give compressor model, serial number and part number. Order assemblies when possible.

<u>REF. NO.</u>	<u>PART NO.</u>	<u>DESCRIPTION</u>	<u>QTY.</u>
		INCLUDES 35, 52, 55(2), 56(2), 58(2), 60(2), 61 W/G54E	
NOT SHOWN	105-1209	OIL,PUMP,SYNTHETIC,BLUE,1 QUART,ESQ	1
NOT SHOWN	610-1226	KIT,FILTER,ASSY,G154,PKG OF 4,G154P	1
NOT SHOWN	610-1186	KIT,ELEMENT,FILTER,L54E,PKG OF 4,L54EP	1
NOT SHOWN	150-1010	ELEMENT,FILTER,AIR,COMPRESSOR,JENNY,L54E	1