



Operating Instructions and Parts Manual Toe Jack

Models JTJ-2ST, JTJ-5ST and JTJ-10ST



(5-Ton model shown)

JET
427 New Sanford Road
LaVergne, Tennessee 37086
Ph.: 800-274-6848
www.jettools.com

Part No. M-454502
Revision A1 05/2014
Copyright © 2014 JET

JTJ-5ST and JTJ-10ST

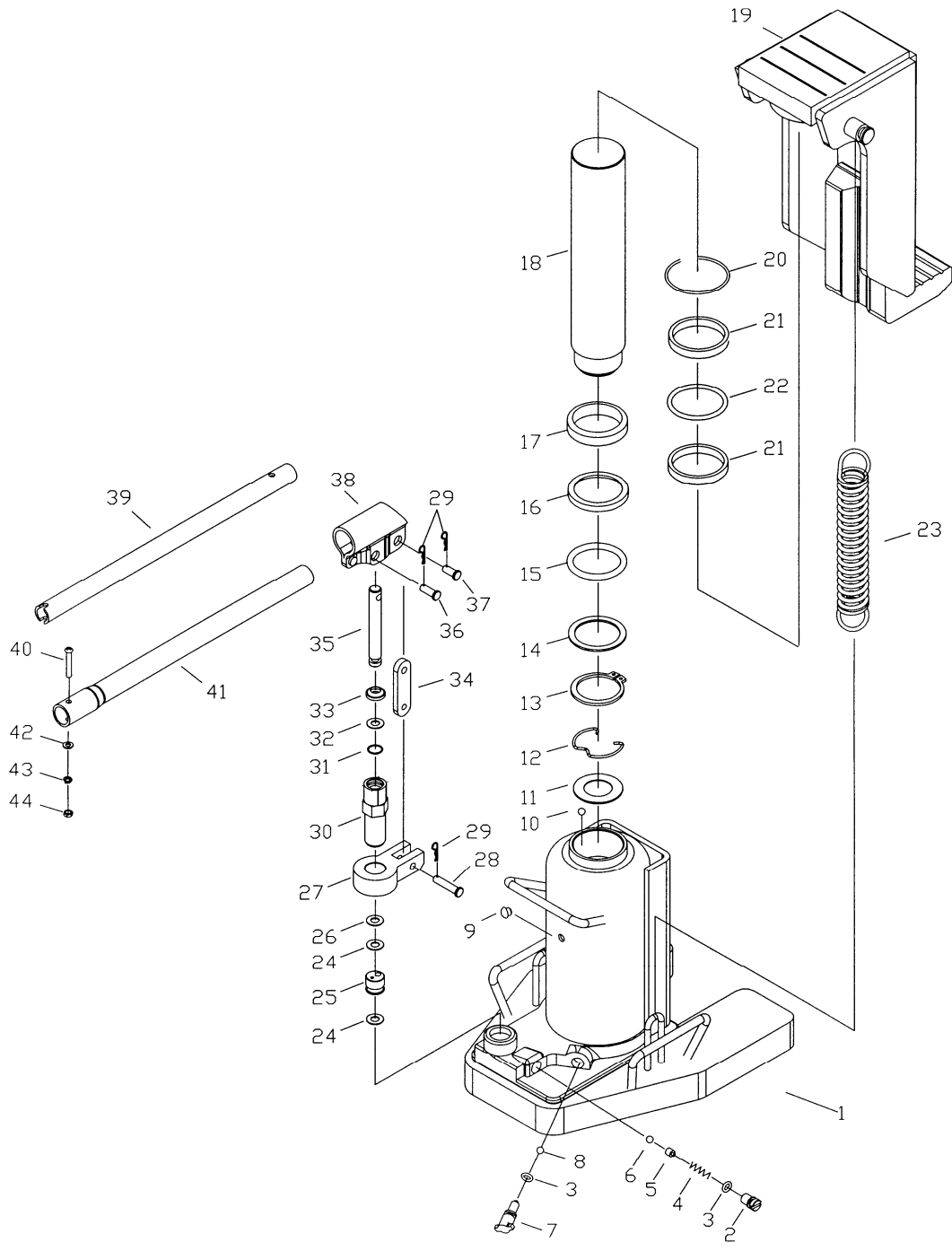

Parts List for JTJ-5ST 5-Ton Toe Jack

Index No.	Part No.	Description	Size	Qty
1	JTJ5ST-01	Body		1
2	JTJ5ST-02	Safety Valve Screw		1
3	JTJ10ST-03	O-Ring	7.1x2.65mm	2
4	JTJ5ST-04	Safety Valve Spring		1
5	JTJ5ST-05	Ball Seat		1
6	SB-4MM	Steel Ball	4mm	1
7	JTJ5ST-07	Release Stem		1
8	SB-6MM	Steel Ball	6mm	1
9	JTJ5ST-09	Oil Fill Plug		1
10	SB-5MM	Steel Ball	5mm	2
11	JTJ5ST-11	Washer		1
12	JTJ5ST-12	Snap Ring		1
13	JTJ5ST-13	Snap Ring	34mm	1
14	JTJ5ST-14	Washer		1
15	JTJ5ST-15	O-Ring	35.5x4.6mm	1
16	JTJ5ST-16	Sealing Washer		1
17	JTJ5ST-17	Piston Ring		1
18	JTJ5ST-18	Ram		1
19	JTJ5ST-19	Toe		1
20	JTJ5ST-20	Snap Ring		1
21	JTJ5ST-21	Bushing		2
22	JTJ5ST-22	O-Ring	42.5x3.55mm	1
23	JTJ5ST-23	Return Spring		2
24	JTJ5ST-24	Copper Washer		2
25	JTJ5ST-25	Oil Valve Assembly		1
26	JTJ5ST-26	Nylon Gasket		1
27	JTJ5ST-27	Link Base		1
28	JTJ5ST-28	Pin		1
29	JTJ5ST-29	Pin		3
30	JTJ5ST-30	Pump Cylinder		1
31	JTJ10ST-31	O-Ring	6.6x3mm	1
32	JTJ5ST-32	Nylon Gasket		1
33	JTJ5ST-33	Dustproof Ring		1
34	JTJ5ST-34	Rod Joint		1
35	JTJ5ST-35	Pump Plunger		1
36	JTJ5ST-36	Pin		1
37	JTJ5ST-37	Pin		1
38	JTJ5ST-38	Handle Socket		1
39	JTJ5ST-39	Rear Handle		1
40	TS-2285302	Pan Head Screw	M5x30	1
41	JTJ10ST-41	Front Handle		1
42	TS-1550031	Flat Washer	M5	1
43	TS-2361051	Lock Washer	M5	1
44	TS-1540031	Hex Nut	M5	1
	JTJ5ST-ID	ID Label (not shown)		1



427 New Sanford Road
LaVergne, Tennessee 37086
Phone: 800-274-6848
www.jettools.com