

HT19 Hedge Trimmer UT-18023-A - Figure A

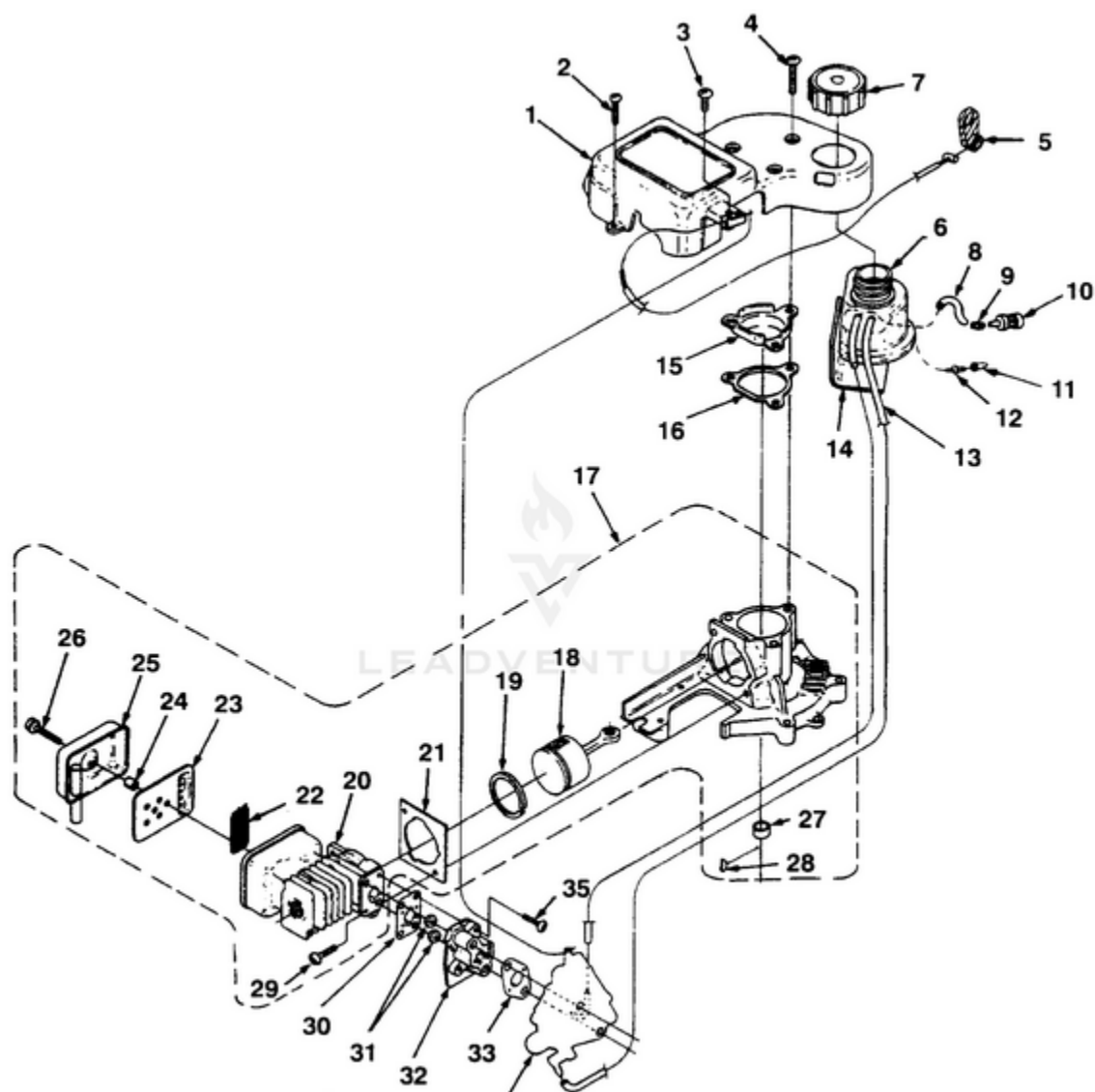

34 Rendered by LeadVenture, Inc.

Ref #	Part #	Description	Qty	Context Note
1	A02571B	COVER-Engine	1	
2	82536	SCREW-Thread Form. (#8 X 3/4")	2	
3	82541	SCREW-Thread Form. (#10 X 1/2")	1	
4	82538	SCREW-Thread Form. (10-24 X 3/4")	3	
5	00959	LEVER-Trigger	1	
6	A04270A	FUEL TANK ASSEMBLY	1	
7	A00982B	CAP-Fuel	1	
8	9477222	TUBING-Rubber (5 1/2")	1	
9	98268	CLAMP-Wire	1	
10	49422	FILTER-Fuel	1	
11	98819	VALVE- Filter	1	
12	01327	FITTING	A/ R	
13	9477224	TUBING-Rubber (6 1/4")	1	
14	00927A	SPACER-Fuel Tank	1	
15	01836A	COVER-Crankcase	1	
16	00946	GASKET-Crankcase	1	
17	A02069B	SHORT BLOCK	1	When ordering a short block for UT18007 you must order items #4, 15 & 16.
18	A01014D	PISTON & ROD	1	
19	00915	RING-Piston	1	
20	A01523B	CYLINDER & MUFFLER ASSEMBLY	1	
21	02059	GASKET-Cylinder	1	
22	00921	SCREEN-Spark Arrestor	1	
23	00920	BAFFLE-Muffler	1	
24	00931	SPACER-Muffler	1	
25	A01838	COVER-Muffler	1	
26	82540	SCREW-Thread Form. (8-32 X 1")	3	
27	01971	SPACER	1	
28	69250	KEY-Woodruff	1	
29	82568	SCREW-Machine (10-24 X 3/4")	2	
30	00932A	GASKET-Heat Dam	1	

Ref #	Part #	Description	Qty	Context Note
31	81208	NUT-Hex (10-24)	2	
32	00917B	HEAT DAM	1	
33	98766A	GASKET-Carburetor	1	
34	A00962A	CARBURETOR (Walbro)	1	Your original carburetor may be identified as Walbro or Zama. Either replacement type will work with your Hedge Trimmer.
	A00933A	CARBURETOR (Zama)	1	
35	825491	SCREW-Thread Form. (10-24 X 1")	2	

HT19 Hedge Trimmer UT-18023-A - Figure B

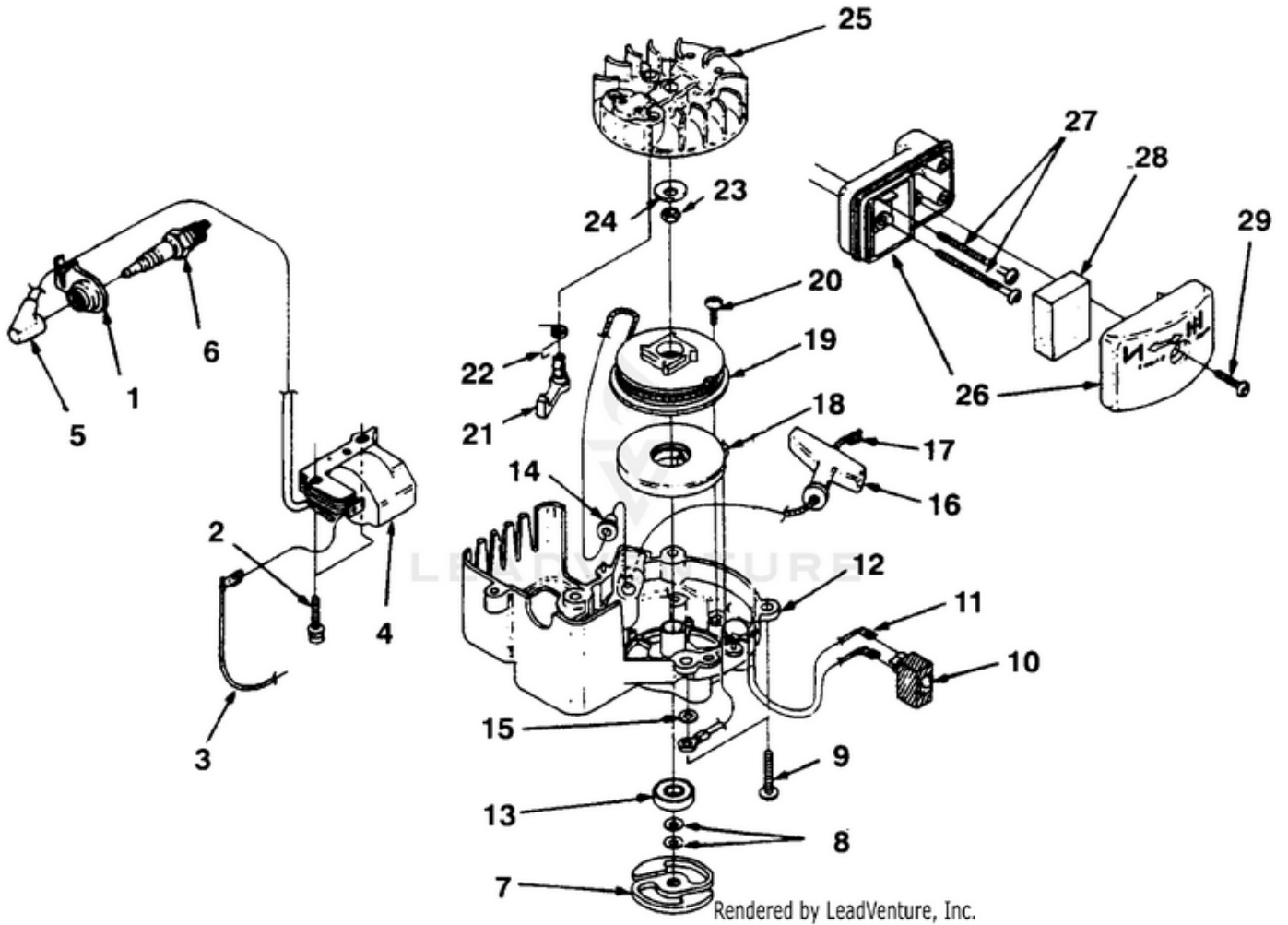

Ref #	Part #	Description	Qty	Context	Note
1	01010A	SHIELD-Spark Plug	1		
2	82540	SCREW-Thread Form. (8-32 X 1")	2		
3	A00942	LEAD-Electrical	1		
	A04446	IGNITION KIT	1		
4	94711CS	MODULE-Ignition	1		
5	A02597	SPARK PLUG BOOT KIT	1		
6	96169S	SPARK PLUG (DJ-7Y)	1		
	79252	SPARK PLUG (RDJ-7Y) (HT17I, HT19I, HT21I)	1		
7	035881	CLUTCH "S"	1		
8	70788	WASHER-Belleville	2		
9	82538	SCREW-Taptite (10-24 X 3/4")	4		
10	00941	SWITCH	1		
10	02497	SWITCH (HT-17I, HT-19I, HT-21I)	1		
11	A00943	LEAD-Ground	1		
12	A01308B	HOUSING-Engine & Pulley	1		
13	98843	BEARING-Ball	1		
14	969811A	BUSHING-Starter	1		
15	84003	WASHER-Flat (#10)	1		
16	02264	GRIP-Starter Rope	1		
17	9789902	ROPE-Starter (42")	1		
18	A97908	SPRING & CONTAINER	1		
19	00924	PULLEY-Starter	1		
20	82541	SCREW-Thread Form. (#10 X 1/2")	2		
21	00928	PAWL-Starter	1		
22	00929	SPRING-Torsion	1		
23	81191	NUT-Hex (7/16-20)	1		
24	01325	WASHER-Conical	1		
25	00923	ROTOR	1		
26	A00335A	AIR FILTER HOUSING	1		
27	82542	SCREW-Machine (10-24 X 2 1/4")	2		
28	00934	FILTER-Air	1		
29	82368	SCREW-Thread Form. (#8 X .750)	1		

HT19 Hedge Trimmer UT-18023-A - Figure C

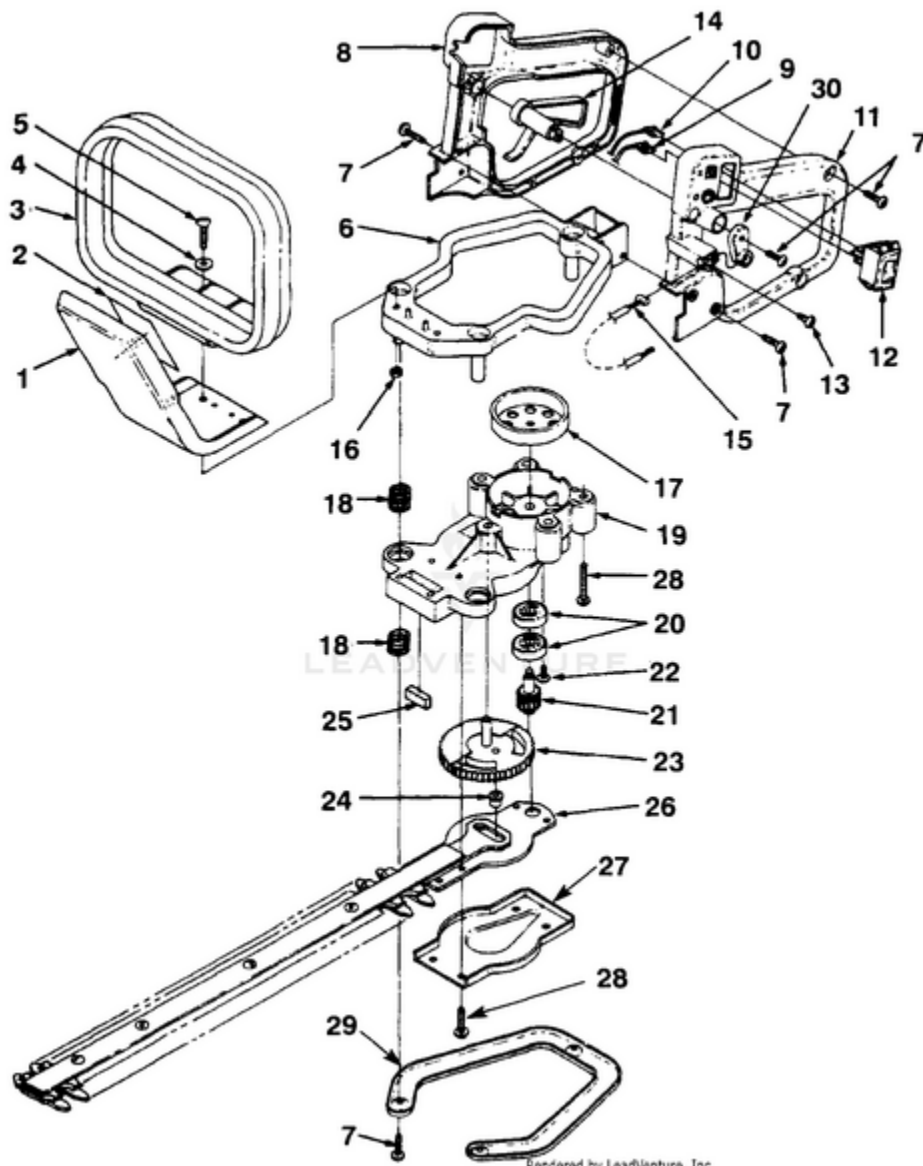

Rendered by LeadVenture, Inc.

Ref #	Part #	Description	Qty	Context	Note
1	00937	GUARD-Hand (HX16, HT17, HT19)	1		
	01972	GUARD-Hand (HT21, HT17I, HT19I, HT21I, HT22)	1		
2	01317A	DECAL-Caution	1		
2	02916A	DECAL -Warning (HT17I, HT19I, HT21I)	1		
3	00936A	HANDLE-Front	1		
4	95249	WASHER-Flat (10-24)	2		
5	82538	SCREW-Thread Form. (10-24 X 3/4")	2		
6	01007	BASE-Vibration Isolator	1		
7	82536	SCREW-Thread Form. (#8 X 3/4")	7		
8	00938	HANDLE-Rear (Right)	1		
9	A00942	LEAD-Electrical	1		
10	A00943	LEAD-Ground	1		
11	00939	HANDLE-Rear (Left)	1		
12	00941	SWITCH	1		
	02497	SWITCH (HT17I, HT19I, HT21I)	1		
13	82541	SCREW-Thread Form. (#10 X 1/2")	1		
14	00958A	TRIGGER	1		
15	01973	CABLE-Throttle	1		
16	81208	NUT-Hex (10-24)	2		
17	00949B	DRUM-Clutch	1		
18	01009	SPRING-Compression	6		
19	A01526	GEAR BOX ASSEMBLY	1		
20	98843	BEARING-Ball	2		
21	A01313	PINION & SCREW ASSEMBLY	1		
22	82541	SCREW-Thread Form. (#10 X 1/2")	1		
23	A01312	GEAR & PIN ASSEMBLY	1		
24	00955	BUSHING	1		
25	00935	BLADE-Seal	1		
26	A00956A	BLADE ASSY. (HX16, HT17, HT17I)	1		
	02741	BLADE ASSY. (HT19, HT19I)	1		
	A01841A	BLADE ASSY. (HT21, HT21I)	1		
	04898	BLADE ASSY. (HT22)	1		
27	00954	COVER-Gear Box	1		
28	82537	SCREW-Thread Form. (#10 X 7/8")	4		
29	01013	BRACE	1		
30	00959	LEVER-Trigger	1		