

3 601 JA5 300

Stand 10-12
Issue 10-01-29

Fig./Abb. 1

Anzugsmomente
Torque values
Couple de serrage
Pares de apriete

Pos 40 = 0,5- 0,8 Nm
101 = 0,8- 1,0 Nm
105 = 1,7- 2,0 Nm
107 = 4,0 5,0 Nm

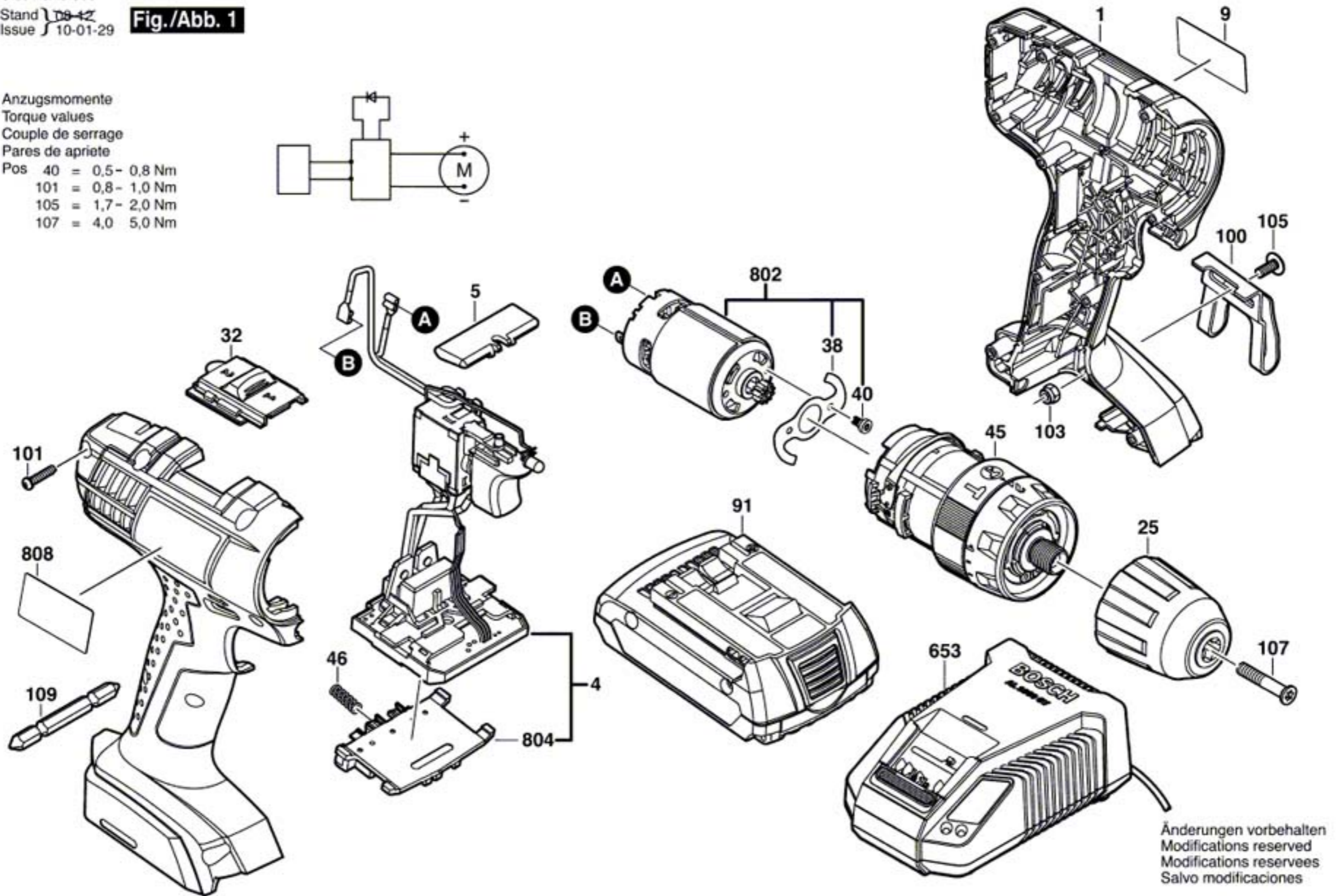
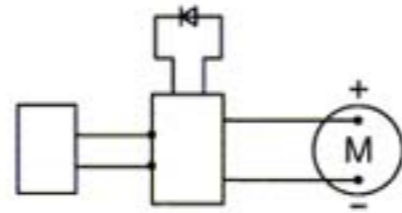

Änderungen vorbehalten
Modifications reserved
Modifications reserves
Salvo modificaciones