

Jig Saw - F 012 457 099 - HD 4570 TYPE 1

Item	Part Number	Description	Illustration	Price	Quantity	Price Group
1	2 610 905 349	Housing	1	-,-	1	-
2	2 610 326 565	Pole Shoe 120V	1	-,-	1	-
3	2 610 326 561	Armature 120V	1	-,-	1	-
3/5	2 610 326 560	Fan	1	-,-	1	-
4	2 610 304 120	Toggle Switch	1	-,-	1	-
5	2 610 302 809	Power supply cord	1	-,-	1	-
6	2 610 360 176	Grommet	1	-,-	1	11
7	2 610 064 973	Cable Grip	1	-,-	1	11
8	2 610 317 477	Nameplate	1	-,-	1	-
9	2 610 904 551	Label	1	-,-	1	-
12	2 610 320 523	Sleeve	1	-,-	1	-
13	2 610 067 674	Ball Bearing	1	-,-	1	-
14	2 610 020 373	Ball Bearing	1	-,-	1	-
16	2 610 320 548	Brush Holder	1	-,-	2	13
17	2 610 038 628	Connecting Wire 260 MM	1	-,-	1	-
18	2 610 038 850	Connecting Cable 45 MM	1	-,-	1	11
19	2 610 315 299	Screw	1	-,-	4	11
21	2 610 326 580	Screw	1	-,-	2	-
22	2 610 326 586	Washer	1	-,-	1	11
23	2 610 328 468	Screw	1	-,-	2	-
26	2 610 326 553	Counterweight	1	-,-	1	-
27	1 619 X00 504	Screw	1	-,-	3	10
29	2 610 326 518	Baffle	1	-,-	1	-
30	2 610 021 427	Retaining snap ring	1	-,-	1	-
31	2 610 024 924	Retaining snap ring	1	-,-	1	-
33	2 610 353 261	Guide Piece	1	-,-	1	-
34	2 610 326 658	Label	1	-,-	1	-
35	2 610 326 514	Cover	1	-,-	1	26
36	2 610 905 348	Handle	1	-,-	1	-
39	2 610 303 953	Washer	1	-,-	2	-
40	2 610 038 673	Lead Wire 185 MM	1	-,-	1	-
41	2 610 326 577	Screw	1	-,-	2	-
42	2 610 326 529	Sleeve	1	-,-	1	13

Item	Part Number	Description	Illustration	Price	Quantity	Price Group
43	2 610 328 497	Thrust Plate	1	-,-	1	-
44	2 610 317 545	End stop	1	-,-	1	11
45	2 610 326 502	Locking Piece	1	-,-	1	-
46	2 610 317 286	Screw	1	-,-	4	-
47	2 610 326 521	Plate	1	-,-	1	-
48	2 610 326 579	Screw	1	-,-	4	-
50	2 610 304 995	Nut	1	-,-	2	-
53	2 610 322 293	Needle-Roller Bearing	1	-,-	2	-
58	2 610 038 851	Connecting Wire 85 MM	1	-,-	1	-
63	2 610 304 524	Screw	1	-,-	1	-
66	2 610 347 161	Screw	1	-,-	1	11
810	2 610 321 617	Carbon-Brush Set	1	-,-	1	24
825	2 610 326 556	Gear	1	-,-	1	-
828	2 610 326 511	Gear Housing	1	-,-	1	-
832	2 610 327 513	Knob	1	-,-	1	-
837	2 610 347 190	Plunger Bar	1	-,-	1	-

Illustration - Type E

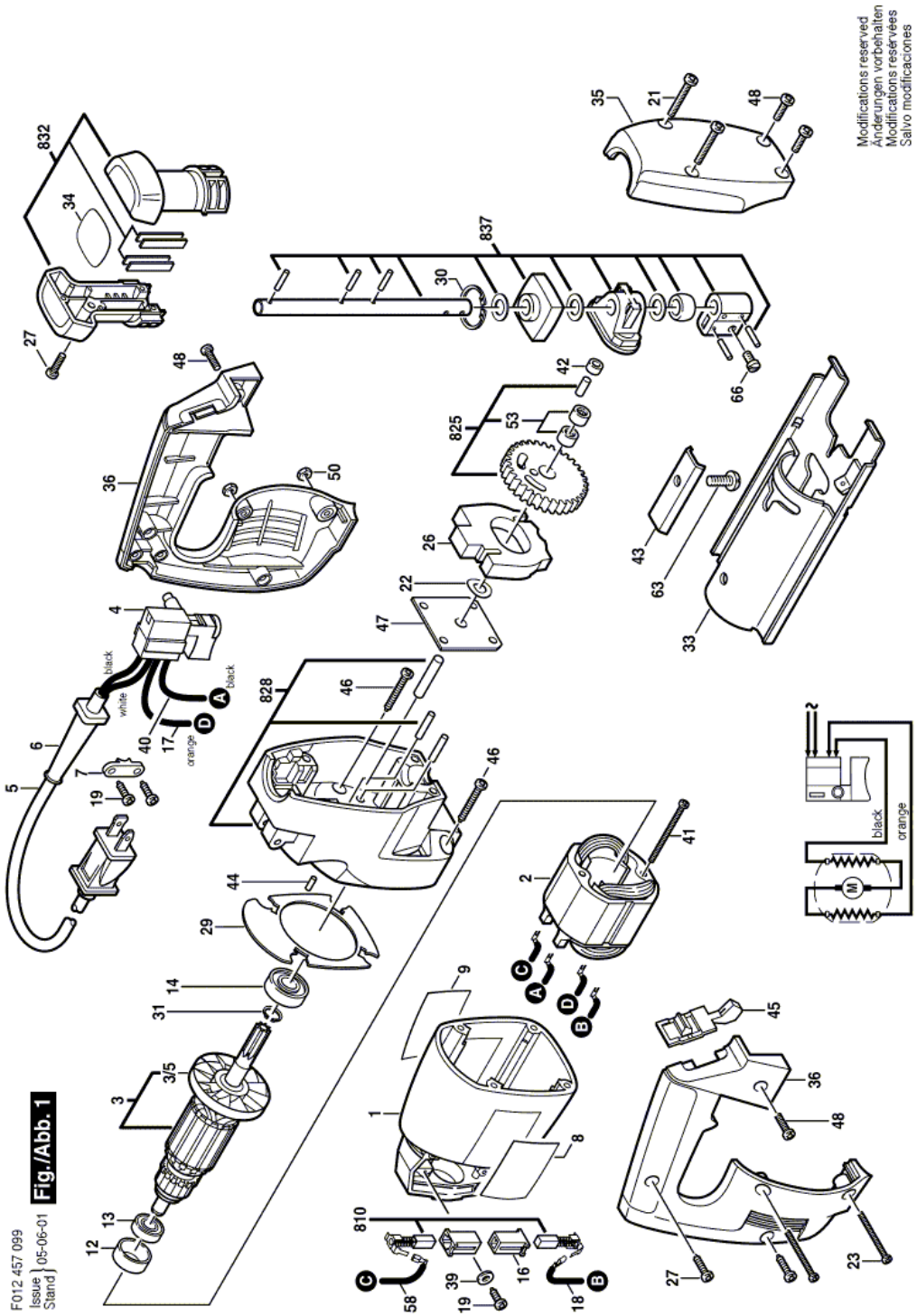

Information subject to change without further notice.