

3 601 B20 000
Issue } 11-11-14
Stand }

Fig./Abb. 1

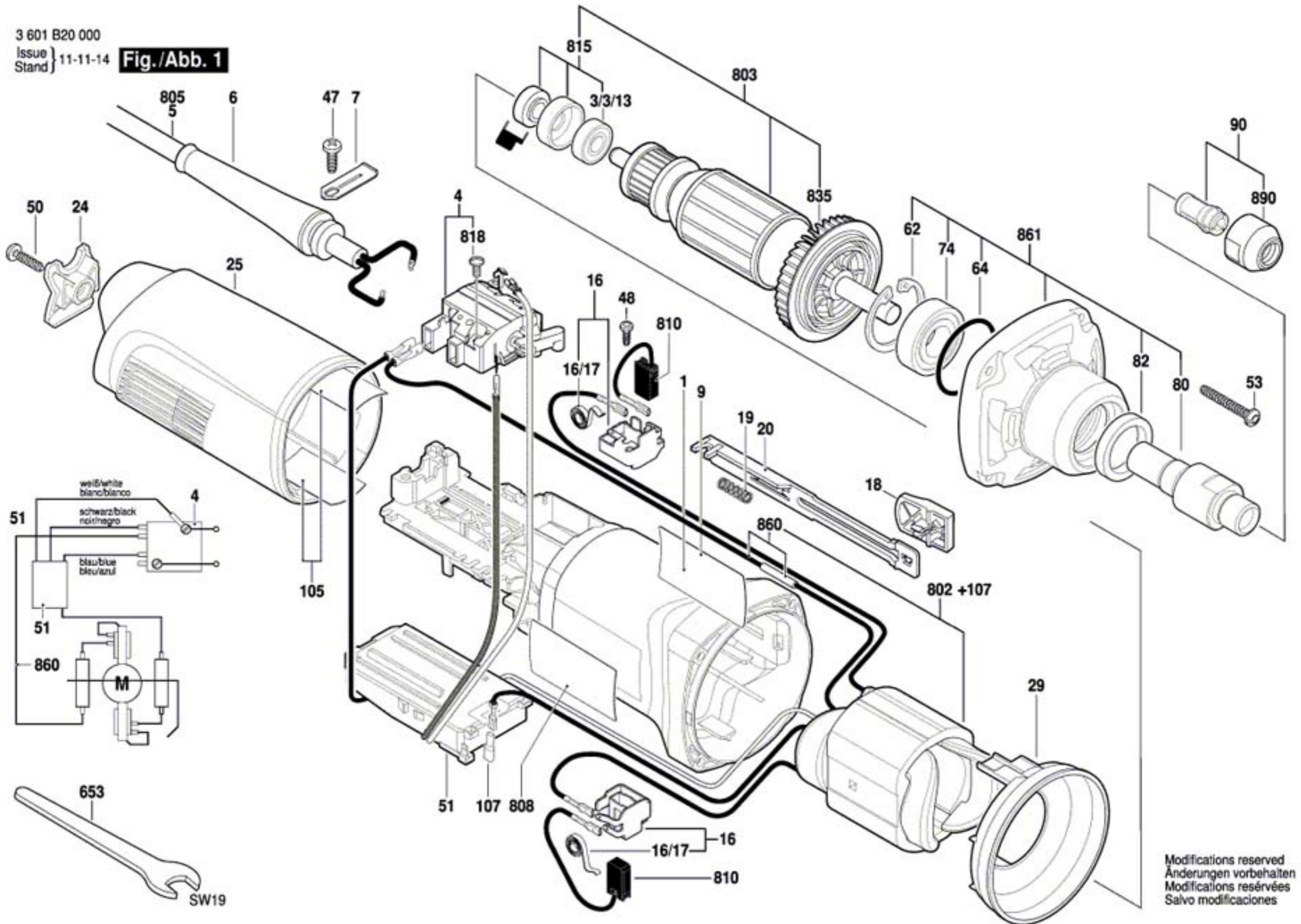

Modifications reserved
Änderungen vorbehalten
Modifications réservées
Salvo modificaciones