



BOSCH

Dry cutter

GCD 12 JL | 3 601 M28 080

Table of Content

Spare parts list.....	2
Illustration - Type.....	6

Spare parts list

Item	Part Number	Description
1	1 609 B00 054	Motor Housing
2	1 609 B00 115	Field 230V
19	1 619 P03 833	Screw ECO-SYN St 3,5x16
22	1 609 B04 610	End cap
23	1 619 P03 832	Screw ECO-SYN St3x12
24	1 619 P03 834	Screw ECO-SYN St3,5x10
25	1 619 P03 835	Thread-forming tap. Screw DIN 7500 C-M6x35
26	1 609 B00 055	Pickup Clip
27	1 600 206 030	Rubber Ring
29	1 619 P03 822	Air-Deflector Ring
38	1 609 B04 620	Locking Pin
39	1 609 B04 621	Compression Spring
40	1 609 B04 678	Spring Pin
42	1 609 B00 780	Screw
47	1 609 B00 068	O-Ring
50	1 609 B04 650	mat seal
96	1 609 B04 660	Pivot Shaft
97	1 619 P03 839	Stop Screw ISO 4027-M 5x8-45H
98	1 609 B04 648	Bushing
99	1 609 B00 024	Torsion Spring
100	1 609 B04 602	Base
103	1 609 B04 637	Clamp Screw
104	1 619 P03 760	Clamping Block
105	1 609 B03 523	Clamp Handle
106	1 609 B04 638	Connecting Rod
107	1 609 B04 639	Clamp Bracket
108	1 619 P03 762	Spring Pin ISO 13337-4x35
109	1 619 P03 752	Spring Pin ISO 1337 4x18
110	1 619 P03 755	Spring retaining ring DIN 471-18
111	1 619 P03 756	Rivet Pin DIN 94-4x22
112	1 619 P03 757	Plain Washer DIN 433-10
113	1 609 B05 442	Mitre Fence
114	1 609 B04 661	Hexagon Bolt
115	1 609 B00 753	Lever

Spare parts list

Item	Part Number	Description
116	1 609 B00 757	Plain Washer
118	1 609 B00 234	Screw
119	1 609 B00 236	Shoulder Screw
120	1 609 B00 232	Locking Lever
121	1 609 B00 237	Compression Spring
122	1 609 B00 644	Retaining ring
124	1 609 B04 641	Guide Plate
125	1 609 B01 600	Locking Pin
126	1 609 B00 601	O-Ring
127	1 609 B00 227	Rubber Bushing
128	1 609 B01 599	Control Screw
129	1 609 B04 633	Leaf Spring
130	1 609 B04 634	Chip box
131	1 609 B04 635	Protective Cover
132	1 609 B04 663	Pivot Pin
133	1 619 P03 827	Socket head cap screw ISO 4762-M 8x20-8.8
134	1 619 P03 829	Spring Washer DIN 127 B8
135	1 619 P03 828	Plain Washer DIN 125 A8
136	1 609 B00 634	Screw
137	1 609 B04 642	Pointer
138	1 609 B05 416	Offset Screwdriver
139	1 609 B05 419	Rubber Bushing
163	1 609 B05 401	Screw
803	1 609 B04 679	Armature assembly 230V
810	1 607 014 171	Carbon-Brush Set
816	1 604 336 048	Brush Holder
824	1 609 B04 683	Extension Stand
825	1 609 B03 533	Bearing Block
826	1 609 B04 692	Arm
4	1 609 B05 400	On-Off Switch
5	1 609 B04 627	Power supply cord
6	1 609 B04 628	Grommet
7	1 619 P03 808	Cable Clip
18	1 619 P03 837	Raised ctsunk head tap sc

Spare parts list

Item	Part Number	Description
31	1 609 B04 603	Upper guard
35	1 609 B01 267	Ball Bearing
37	1 609 B04 619	Bearing
41	1 609 B04 622	Bearing cover
43	1 609 B04 623	Flange
44	1 609 B04 624	Flange
45	1 609 B04 625	Flange Bolt
46	1 609 B04 664	Chip Deflector
48	1 609 B00 978	Screw
49	1 609 B04 649	Screw
52	1 609 B04 605	Switch Handle
54	1 609 BP7 059	Connection Block
55	1 609 B04 668	Switch-Pawl
56	1 609 B04 608	Carrying Handle
57	1 609 B04 652	Screw
58	1 609 B00 655	Screw
59	1 609 B01 356	Cyl Head tapping screw
60	1 619 P03 931	Ring
61	1 609 B00 637	Tapping Screw
81	1 609 B01 561	Screw
83	1 619 P03 802	Shoulder Screw
84	1 619 P03 841	Spring Washer DIN 127 B6
85	1 609 B05 417	Special Screw
86	1 609 B00 931	O-Ring
87	1 609 B04 611	Locking Lever
88	1 609 B04 612	Locking Lever
89	1 609 B04 647	Bushing
90	1 609 B04 657	Torsion Spring
91	1 609 B03 779	Shoulder Screw
92	1 609 B00 730	Lock Nut
93	1 609 B04 658	Torsion Spring
94	1 609 B03 570	Self-locking nut
95	1 609 B04 659	Screw
140	1 609 B04 636	Linkage
141	1 609 B00 703	Plain Washer

Spare parts list

Item	Part Number	Description
142	1 609 B04 667	Bushing
143	1 609 B01 956	Retaining clip
144	1 609 B00 971	Screw
146	1 609 B05 392	Switch
157	1 609 B04 644	Cover
158	1 609 B04 643	Protecting Cover
159	1 609 B01 667	Screw
160	1 609 B01 663	Screw
165	1 609 B05 421	Mounting Plate
822	1 609 B04 681	Spindle With Gear
823	1 609 B04 682	Spindle With Gear
827	1 609 B04 693	Lower guard
828	1 609 B04 694	Soft Start-Up Module
829	1 609 B04 695	Electronic Module
831	1 609 B01 726	Laser
161	1 609 B01 549	Connecting Cable
830	1 609 B04 696	Wire

Illustration - Type - E

3 601 M28 040
 Stand }
 issue } 13-08-22 **Fig./Abb. 1**

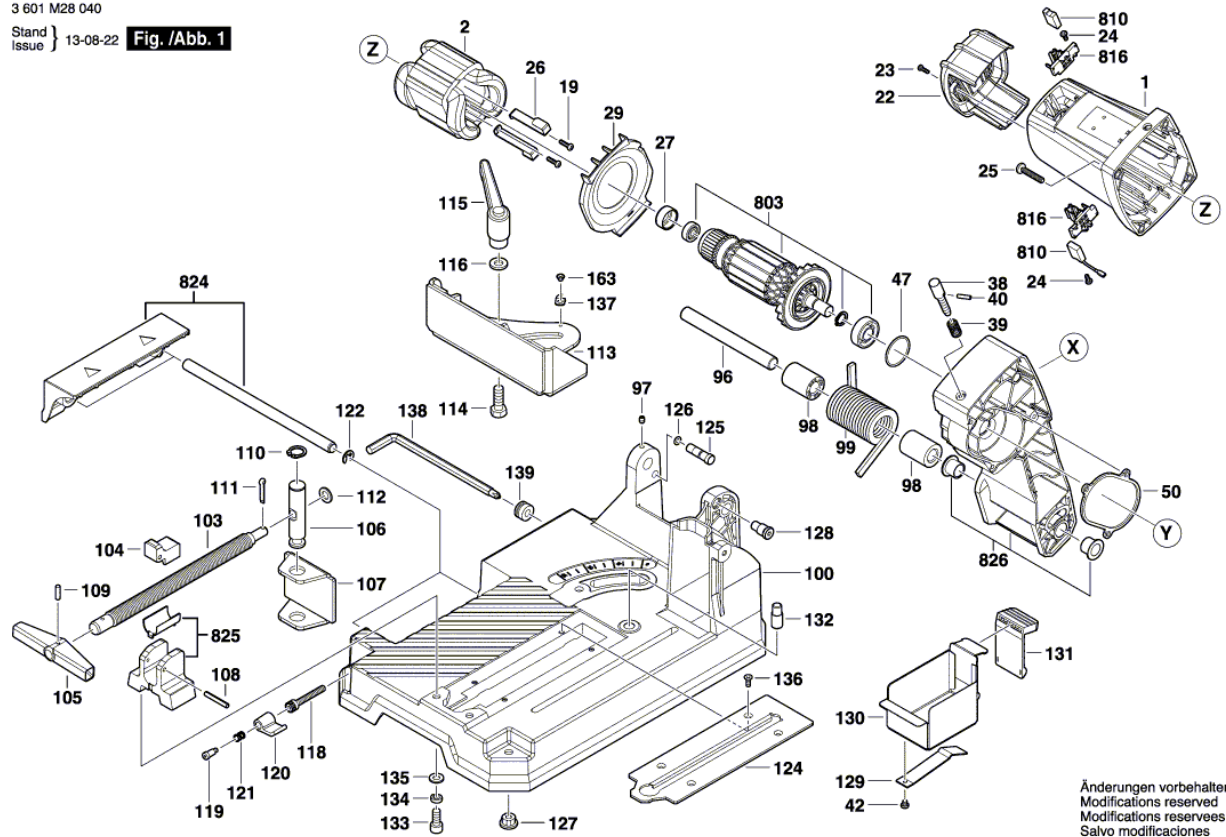

Illustration - Type - E

