

PART NO. 0H9250

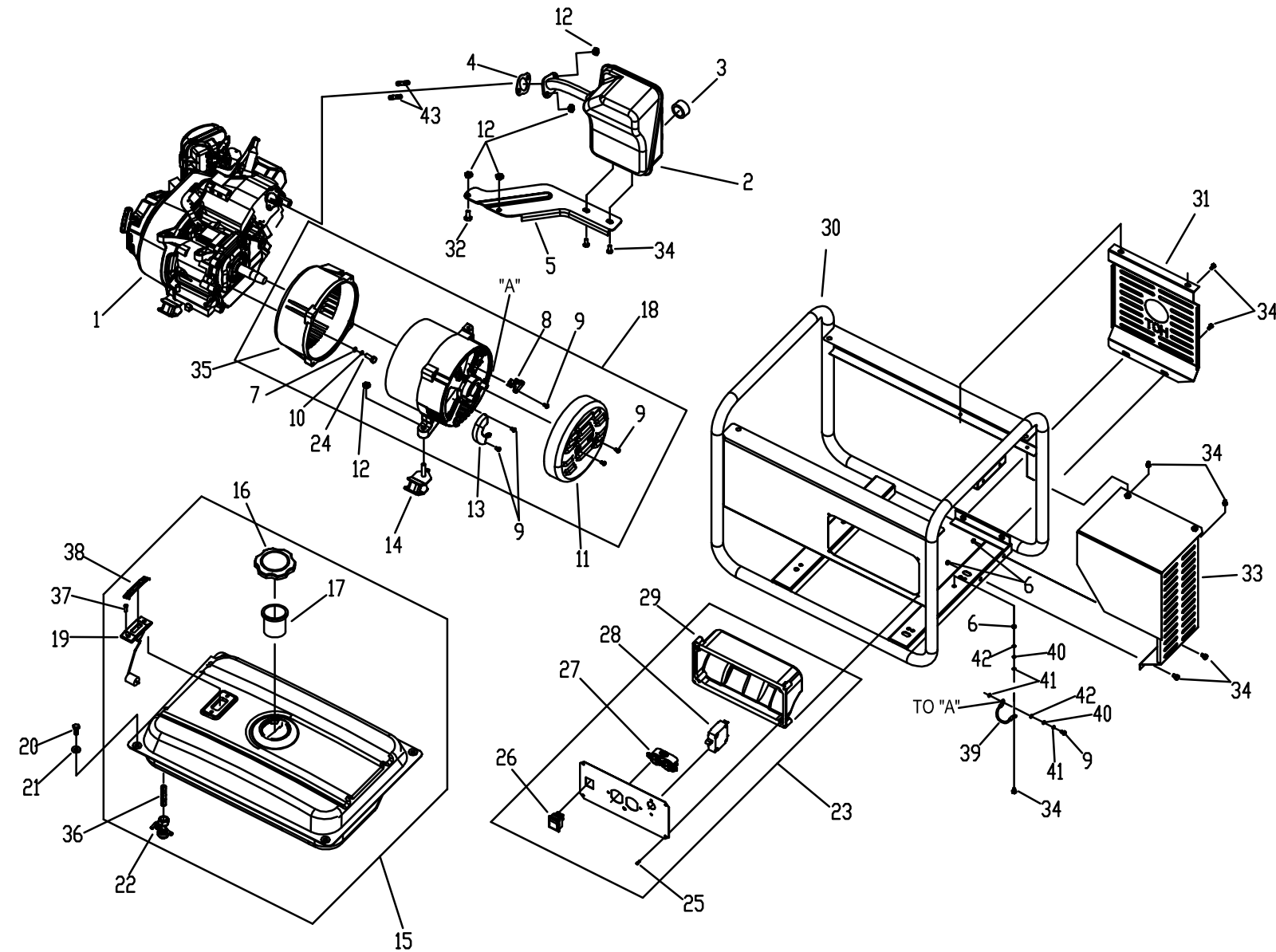

ITEM	PART #	QTY.	DESCRIPTION
1	0J0818	1	ENGINE 163CC PULL START UP
2	0H3376	1	MUFFLER,163/208CC PORTABLE
3	0H3377	1	SPARK ARRESTOR, 163/208CC
4	0H3378	1	GASKET,MUFFLER 163/208CC
5	0H3378A	1	BRACKET MUFFLER MNT EPA PH3
6	0E8388	3	NUT, HEX FLANGE WHIZM 6-1.0
7	070008	4	WASHER, FLAT M8
8	0J08190101	1	BRUSH FOR ALTERNATOR 0H1281
9	091526	6	SCREW, PPHM M5-0.8 x 12
10	070006	4	WASHER, LOCK M8
11	0H8254	1	COVER ALTERNATOR 1800W
12	067989	8	NUT, HEX FLANGE WHIZM 8-1.25
13	0J08190103	1	AVR FOR ALTERNATOR 0H3578
14	0H3415	4	VIBRATION MOUNT W/M8-1.25 STUD
15	0H9264	1	ASSEMBLY, FUEL TANK GP 4 GALLON
16	0H0775	1	FUEL CAP, VENTED
17	0H1326	1	FUEL FILTER
18	0J0819	1	ASSEMBLY ALTERNATOR 1800W
19	0H3383	1	GAUGE, FUEL 4 GALLON TANK
20	039253	4	SCREW, HHC M8-1.25 x 20
21	060190	4	WASHER, FLAT 0.34ID x 1 OD
22	0H3384	1	VALVE, FUEL SHUTOFF 4 GALLON TANK
23	0J0820	1	ASSY RECEPTACLE PANEL 1800W
24	043107	4	SCREW, HHC M8-1.25 x 25
25	0G8382	8	SCREW, PPH #8-16x0.96"
26	0H3414	1	SWITCH, IGNITION ON/OFF
27	0G8507	1	OUTLET, 20A 120V DUPLEX
28	0J0823	1	CB 1P 15A
29	0H3386	1	BACK BOX,C-PNL 1.8/3.25KW
30	0J0825	1	ASSY FRAME 1-PC 1800W UP
31	0H3389	1	HEAT SHIELD, EXHAUST SIDE
32	039414	1	SCREW, HHC M8-1.25 x 35
33	0H3390	1	HEAT SHIELD, EXHAUST FRONT
34	0G1705	7	SCREW, HHC M6-1.0 x 14
35	0H7383	1	ADAPTOR CSTNG ENG/ALT 1.8KW
36	0H3873	1	FILTER, FUEL VALVE
37	0E9509	2	SCREW, PFHM M6-1.0 x 12
38	0H1359	1	PLATE, FUEL GAGE
39	0G8753C	1	WIRE ASSY GND ALT TO BASE
40	022097	2	WASHER LOCK M6-1/4"
41	026850	2	WASHER LOCK EXTERNAL TOOTH 1/4"
42	051713	2	WASHER FLAT M5
43	045761A	2	STUD M8-1.25 X 30

E.C.O.	REV.	DATE
-	A	10/21/10
J-1844	B	4/24/12

DO NOT SCALE

GROUP

MODELS: 05981-0 & 059811
1800W PULL START

EXPLODED VIEW: EV 1800W PULL START		GENERAC POWER SYSTEMS P.O. BOX 8 WAUKESHA, WIS. 53186	
DRAWN BY: DMC	DATE: 7/28/10	FIRST USE:	05981-0
CHECKED BY: KEVIN COLE	DATE: 8/11/10	PART NO.:	0H9250
APPROVED BY: GREG MATHENY	DATE: 10/19/10	REV.:	B
RELEASED FOR PRODUCTION BY: K. BAUER	DATE: 10/21/10		