

# FLEX

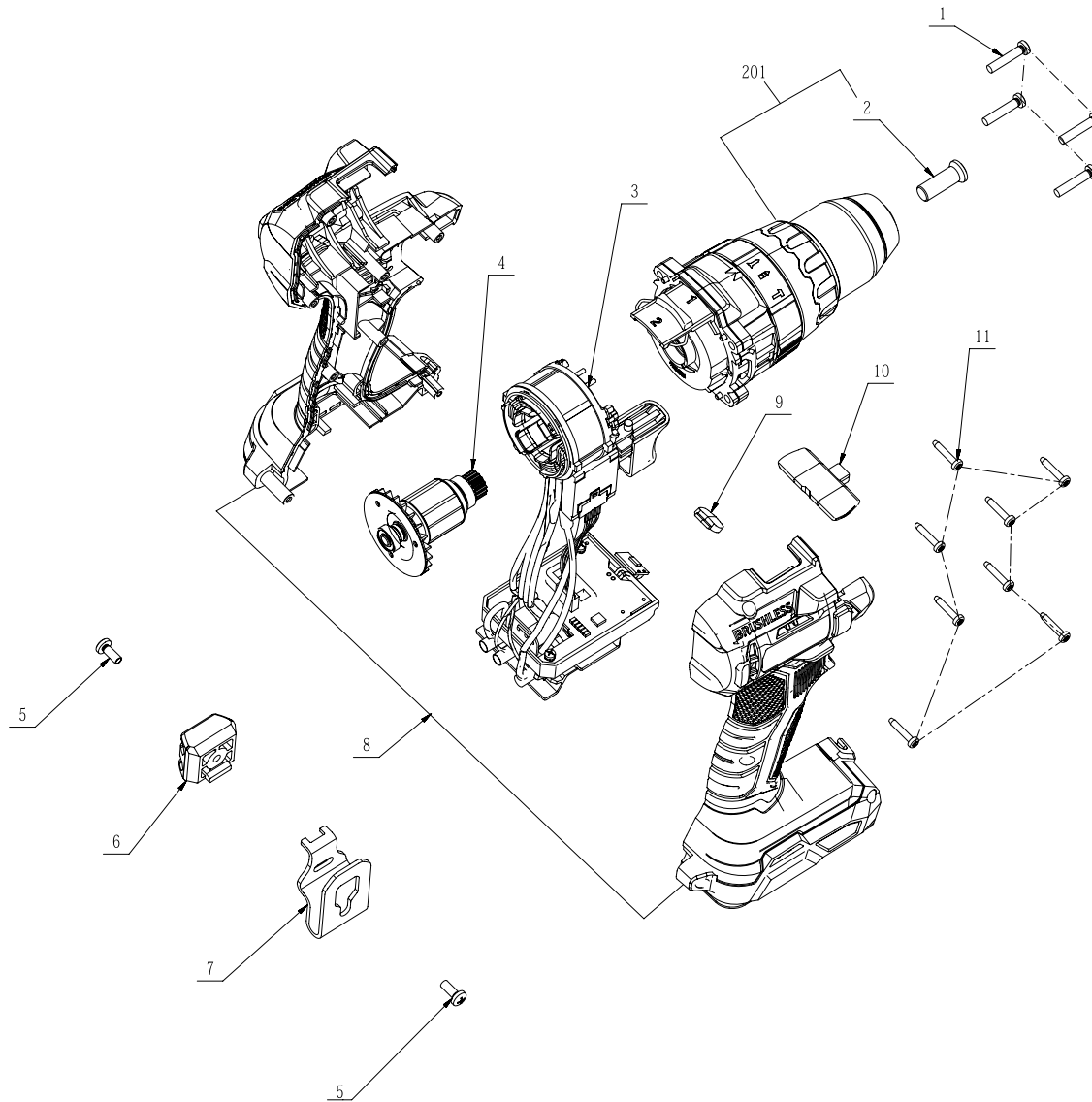

No.	Product Model#	Part Number	Description	Qty
1	FX1251	5610248003	Tapping Screw	4
3	FX1251	2823607002	Stator and Electronic Components	1
4	FX1251	2751035002	Rotor Set	1
5	FX1251	5620039010	Screw	2
6	FX1251	3127743001	Bit Holder	1
7	FX1251	3707622001	Buckle	1
8	FX1251	2827518002	L R Housing Set	1
9	FX1251	3127733001	LED Cover	1
10	FX1251	3131367001	F/R Button	1
11	FX1251	5610241002	Screw	8
201	FX1251	2828349001	Gear Box and Chuck Assembly	1
2	FX1251	5610400001	Hexalobular Socket Raised Countersunk Head Screw	1