

(4) GO-203-2
(4) GO-206-1

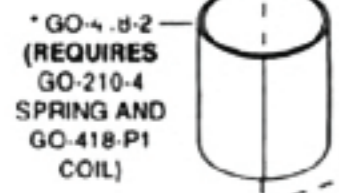

COIL PART # ON TOP

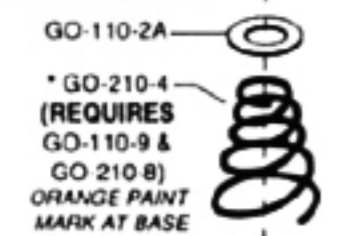
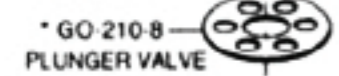
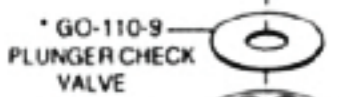
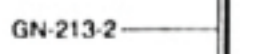
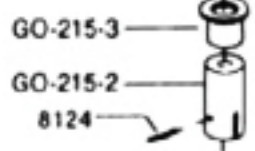
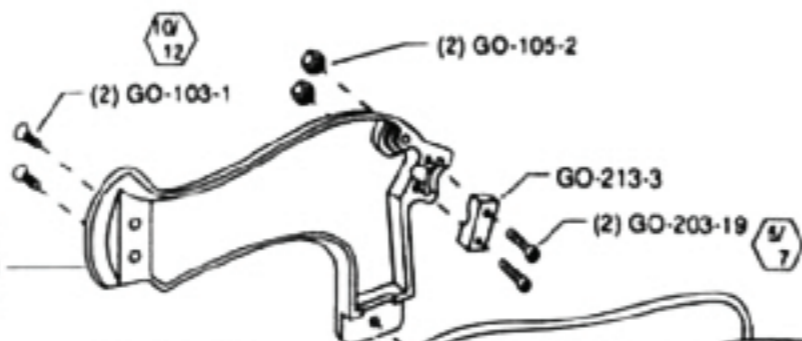
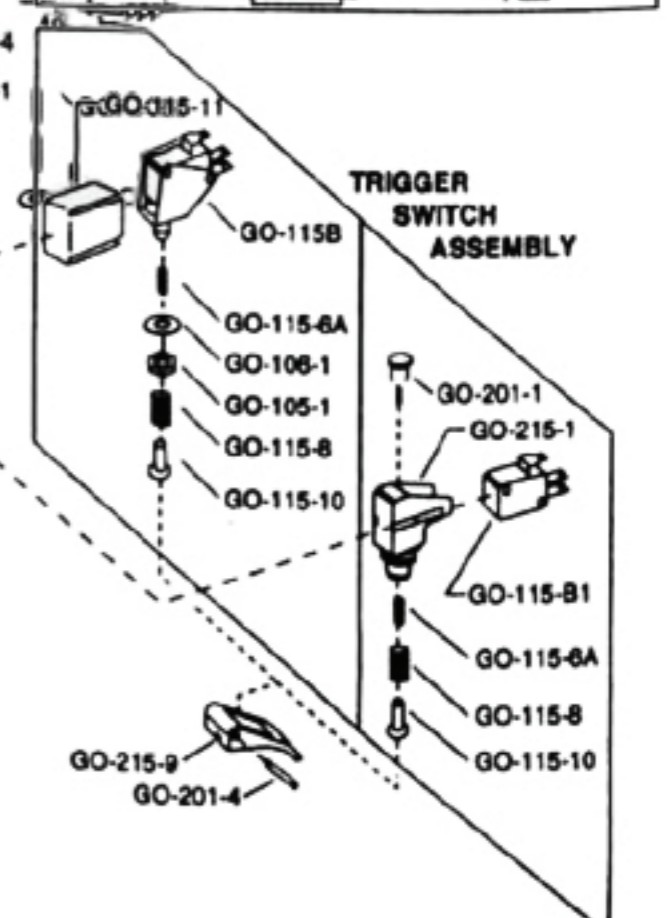
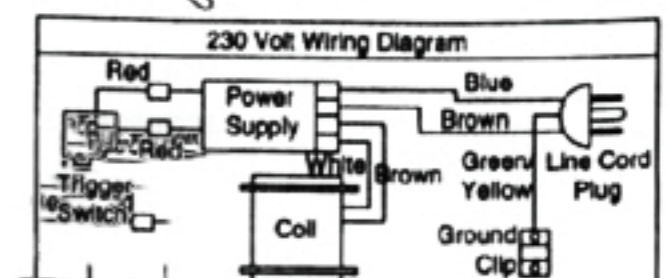
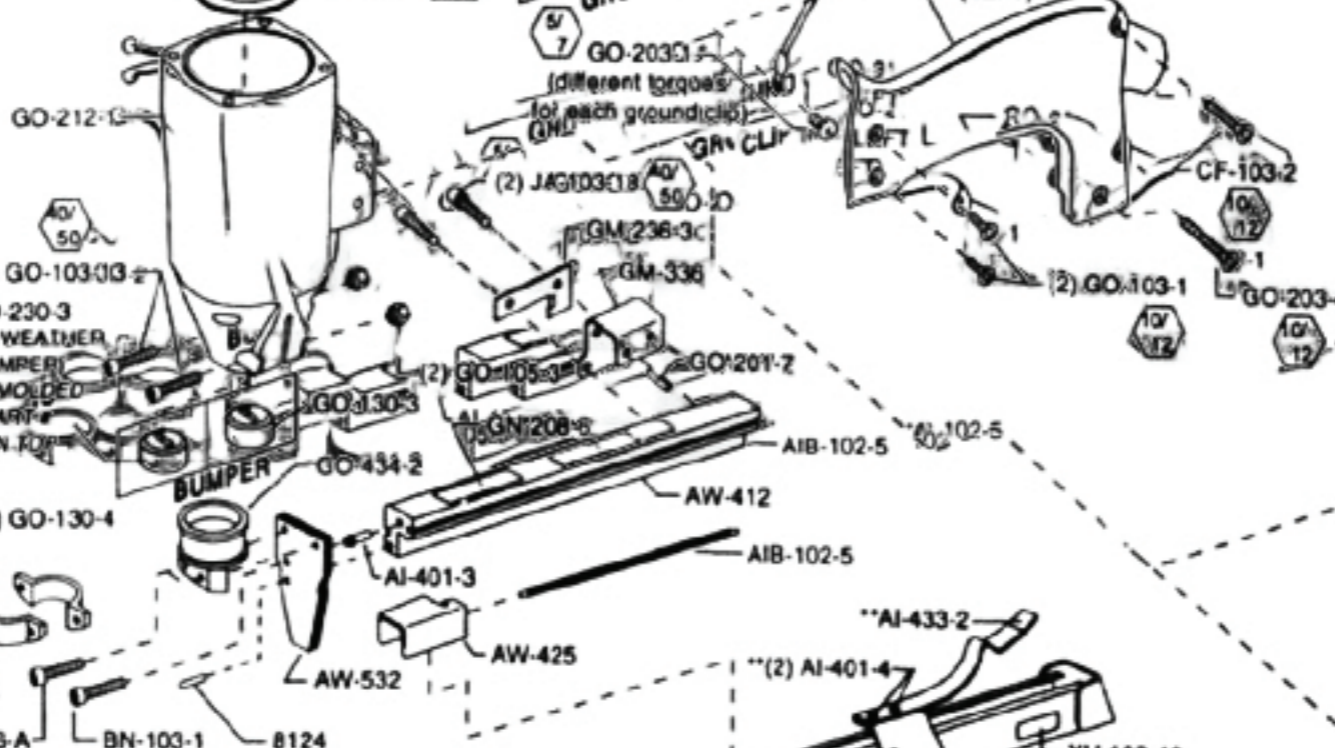
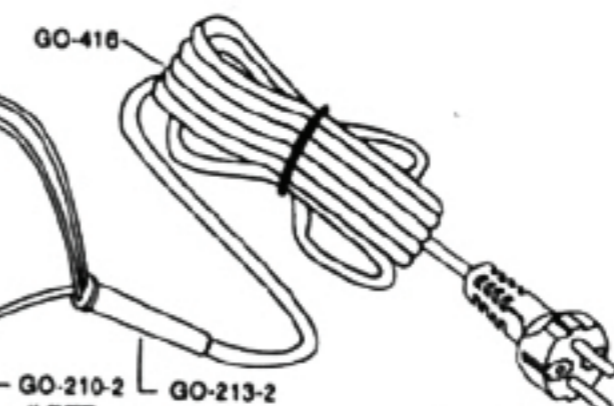
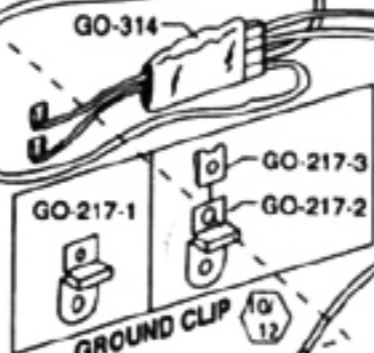

ELECTRICAL REPAIRS MUST BE PERFORMED BY QUALIFIED SERVICE PERSONNEL ONLY
EL SERVICIO DE REPARACION ELECTRICA TIENE QUE SER REALIZADO POR PERSONAL TECNICO CALIFICADO