

125-140 IN LBS.
OF TORQUE
(144-161 CM-KG)
4 PLACES

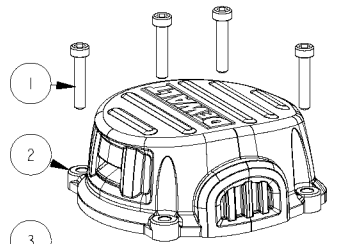

45-55 IN LBS.
OF TORQUE
(52-63 CM-KG)

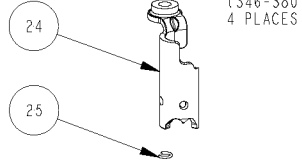
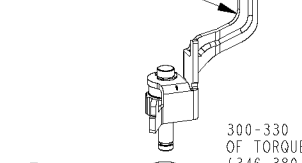
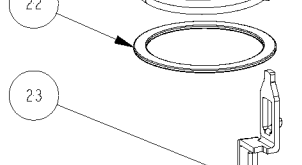
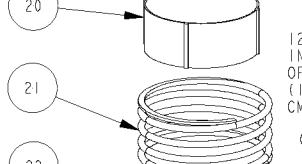
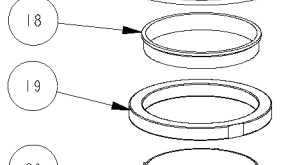
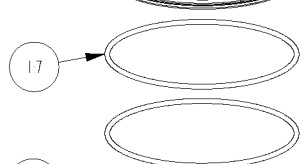
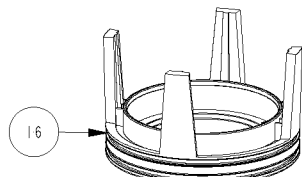
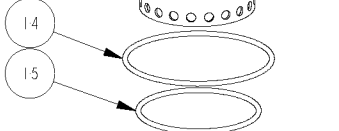
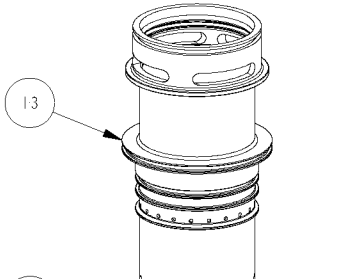
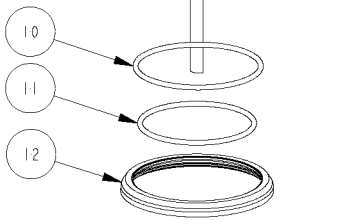
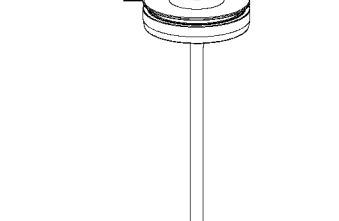
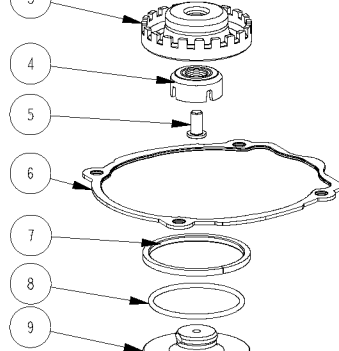

125-140
IN LBS.
OF TORQUE
(144-161
CM-KG)

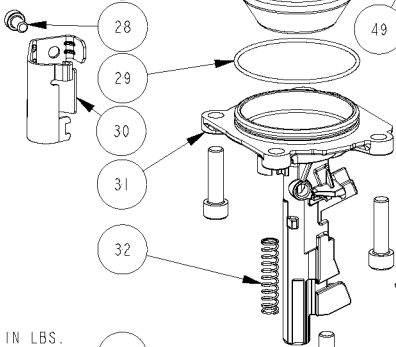

300-330 IN LBS.
OF TORQUE
(346-380 CM-KG)
4 PLACES

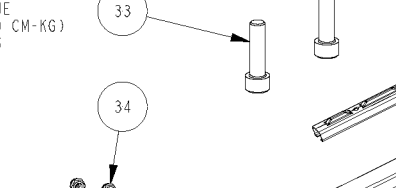

20-30 IN LBS.
OF TORQUE
(23-34 CM-KG)
2 PLACES

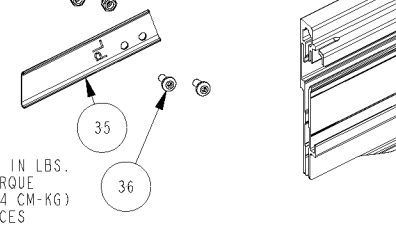

125-140 IN LBS.
OF TORQUE
(144-161 CM-KG)

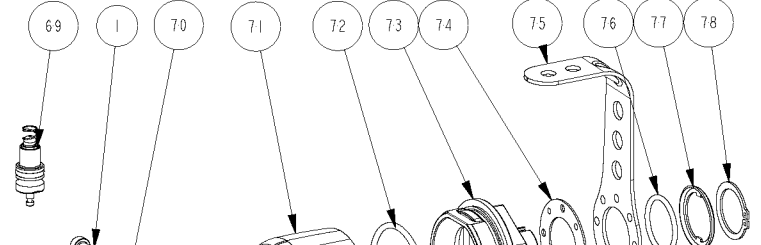

60-70 IN LBS.
OF TORQUE
(69-81 CM-KG)
2 PLACES

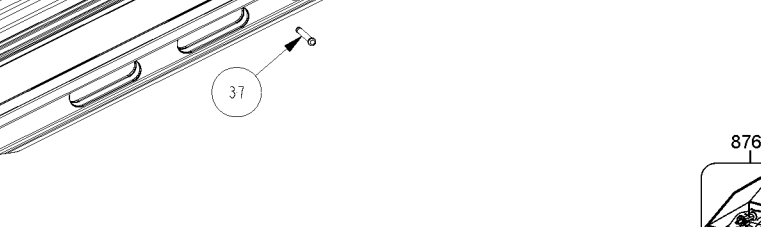
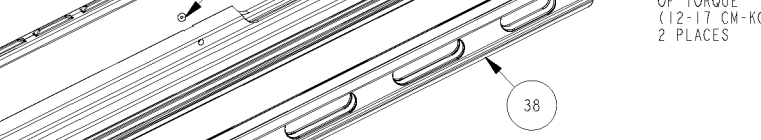
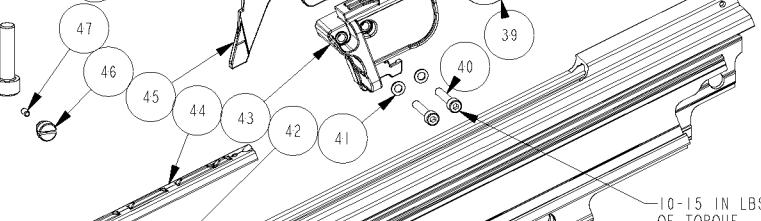
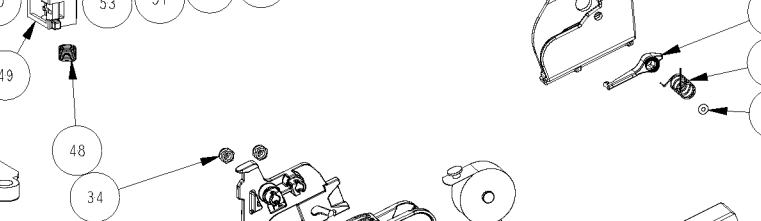
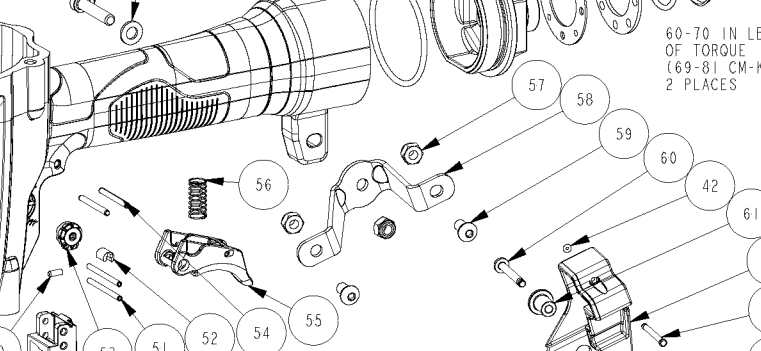

10-15 IN LBS.
OF TORQUE
(12-17 CM-KG)
2 PLACES

Parts List for DWF83PL Type 0

Item Number	Part Number	Description	Qty Required
1	MSC6100-30	SCREW-SHCS-M6X1.00X3	5
2	9R208315	CAP	1
3	9R208267	EXHAUST BUTTON	1
4	9R198239	PISTON STOP	1
5	9R198240	EXHAUST SCREW	1
6	9R209104	GASKET	1
7	9R209763	PISTON RING	1
8	850242	O-RING-1.799X.103	1
9	F83PL-DK	DRIVER KIT	1
10	9R209130	O-RING 63.70X2.62MM	1
11	9R209131	O-RING 57.75X2.62MM	1
12	9R208325	CYLINDER SEAL	1
13	9R208321	CYLINDER	1
14	9R209157	O-RING 75.10X2.62MM	1
15	9R209132	O-RING 61.10X2.62	1
16	9R209788	CYLINDER BULKHEAD	1
17	9R209133	O-RING 97.5X2.62MM	2
18	9R198280	CHECK SEAL	1
19	9R213407	RING RETAINER	1
20	9R215027	VIBRATION DAMPER	1
21	9R209143	CYLINDER SPRING	1
22	9R208390	BOTTOM RING	1
23	9R208383	CONTACT ARM ASSY.	1
24	9R209789	LOWER CT, DWF83PL	1
25	9R209147	RETAINER RING	1
26	9R209109	EXHAUST PLUG	1
27	F83-BK	BUMPER KIT	1

Parts List for DWF83PL Type 0

Item Number	Part Number	Description	Qty Required
28	MSC6100-10	SCREW	1
29	9R208346	O-RING 62.50X2.00MM	1
30	9R208354	TRIP COVER	1
31	9R209794	NOSE, DWF83PL	1
32	9R209138	LOWER CT SPRING	1
33	MSC8125-30	SCREW-SHCS M8X30	4
34	MHE4070-100	ELASTIC STOP NUT-M4	2
35	9R210320	MAG. PLATE, DWF83PL	1
36	9R195700	SCREW, SFHCS, M4X10	2
37	121407	PIN-SPECIAL	1
38	9R208309	MAGAZINE DWF83PL	1
39	F83-CFS	CONSTANT FCE SPRING	1
40	180531	SCREW-SHCS-M4X0.70X2	2
41	9R209762	WASHER	2
42	166797	O-RING-.056X.060 NBR	1
43	9R209099	PUSHER HANDLE	1
44	121406	LINER-NAIL GUIDE	1
45	9R209098	PUSHER DWF83PL	1
46	9R208339	MAGNET HOUSING	1
47	9R208338	MAGNET	1
48	9R209790	CONTACT ARM SPRING	1
49	9R208355	ARM GUIDE	1
50	180484	SCREW-SET-M3X8MM	1
51	106058	PIN-SPRING-M3X32	2
52	184508	BUSHING	1
53	9R208358	MODE SWITCH BUTTON	1
54	174345	PIN SPRING	2

Parts List for DWF83PL Type 0

Item Number	Part Number	Description	Qty Required
55	9R213415	TRIGGER ASSEMBLY	1
56	9R198242	TRIGGER SPRING	1
57	MHE6100-100	NUT-ESN M6X1	3
58	9R209107	MAG. BRACKET DWF83PL	1
59	MSB6100-12	SCREW-SBHCS-M6X1.00X	2
60	9R209764	SPECIAL PIN	1
61	9R209100	PUSHER LATCH SPACER	1
62	9R209096	MAG. END CAP	1
63	9R209141	SPECIAL PIN	1
64	9R209103	PUSHER LATCH	1
65	9R198241	LATCH SPRING	1
66	9R209765	O-RING 2.20X1.60MM	1
67	9R208350	MODE SWITCH PIN	1
68	188850	SPRING	1
69	TVA20	TRIGGER VALVE ASSY.	1
70	MPW6.3	WASHER-PWN M6	1
71	9R208318	FRAME	1
72	9R208337	O-RING 52.00X3.00MM	1
73	9R208324	END CAP	1
74	9R208291	HOOK SEAT PLATE	1
75	9R208290	HOOK	1
76	174309	O-RING-1.049X.103	1
77	9R188812	CAP-HOOK	1
78	9R208349	C-RING 26MM EXTERNAL	1
876	F83-RK	REBUILD KIT	1