

861

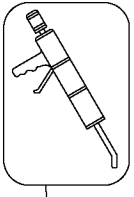

800

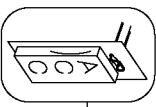

856

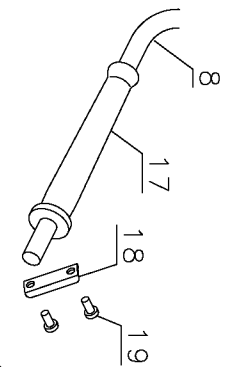

8

17

18

19

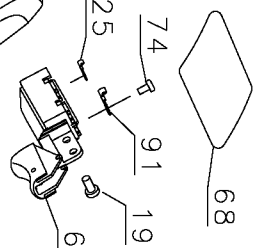

68

20

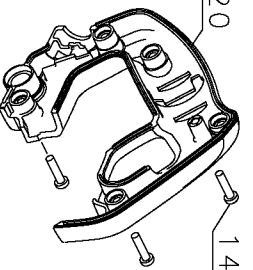

14

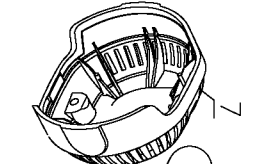

7



78

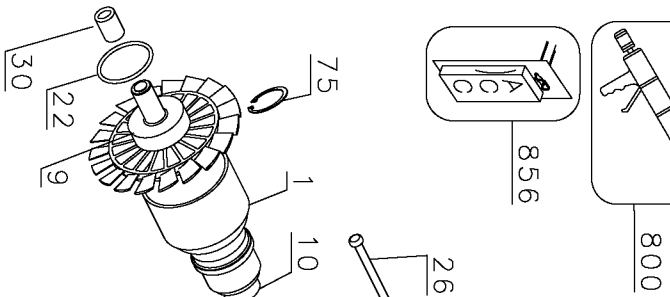

75

1

10

30

22

9

28

26

2

4

5

16

3

15

14

24

13

12

28

2

4

5

16

3

15

14

24

13

12

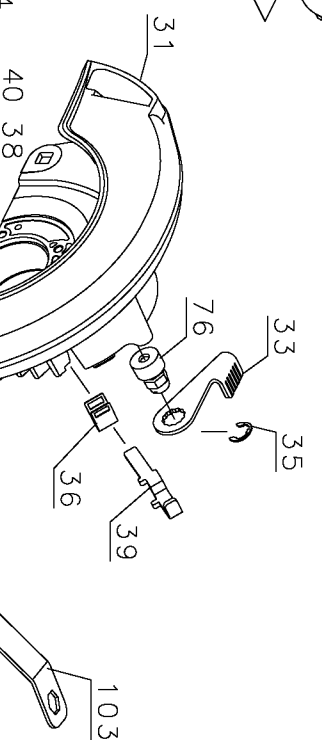

31

76

33

35

36

39

103



40

38

48

76

33

35

36

39

103

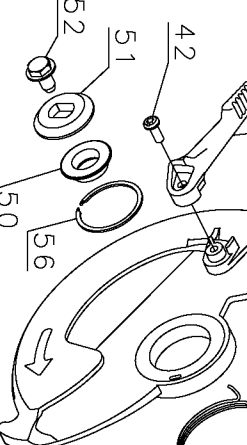

54

53

47

44

40

38

48

76

33

35

36

39

103

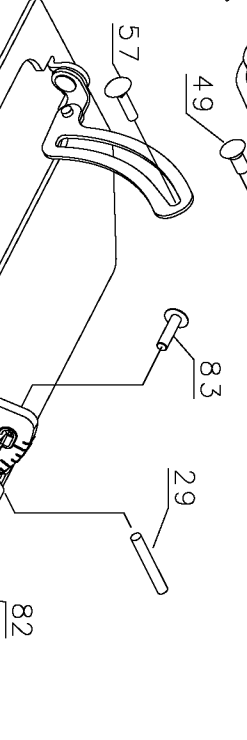

60

57

49

83

29

82

80

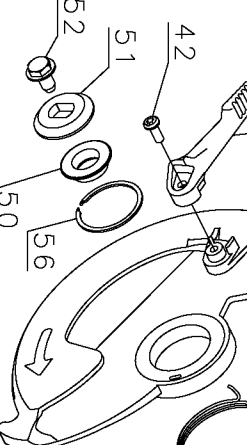

55

42

51

52

50

56

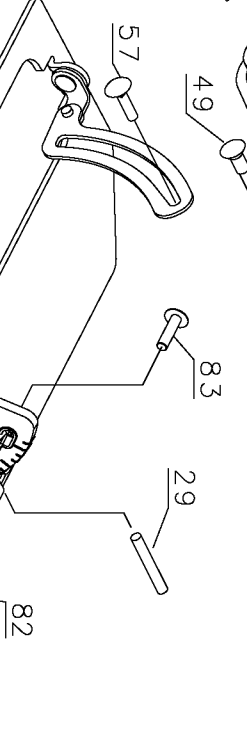

60

57

49

83

29

82

80

Parts List for DW366-BR Type 1

Item Number	Part Number	Description	Qty Required
1	389530-04S	ARMATURE & BRGS	1
2	5140117-11	FIELD	1
3	N032830	BRUSH & LEAD	2
4	N065058	BRUSH RING ASM	1
5	398943-00	TORSION SPRING	2
6	389524-00	SWITCH	1
7	389510-00	END CAP	1
8	330122-72	CORD & PLUG	1
9	605040-27	BALL BEARING	1
10	330003-60	BEARING	1
12	330019-15	SCREW	1
13	389553-00	HANDLE	1
14	330019-13	SCREW,M4X19	9
15	389511-01	FIELD CASE	1
16	145312-00	PLUG,RUBBER	1
17	330005-02	PROTECTOR, CORD	1
18	381065-00	CORD CLAMP	1
19	330019-10	SCREW	3
20	389519-01	HANDLE COVER	1
22	701297-00	O RING	1
24	330045-21	SCREW	3
25	053650-00	TERMINAL	2
26	330019-30	SCREW	2
28	389507-00	BAFFLE	1
29	389562-00	PIN	1
30	330004-06	BEARING,NEEDLE	1
31	N036345	UPPER GUARD ASSY	1

Parts List for DW366-BR Type 1

Item Number	Part Number	Description	Qty Required
33	145347-00	LEVER,LOCK	1
35	152211-00	RING,RETAINING	1
36	389506-00	SPRING	1
38	389563-00	FELT SEAL	1
39	612472-00	SPINDLE LOCK	1
40	647099-00	O-RING	1
42	098094-13	SCREW	1
44	648222-01SV	SPINDLE & GEAR ASSY.	1
47	647098-00	SHOLDER SCREW	3
48	381066-00	BUMPER	1
49	381075-00	SHOULDER SCREW	1
50	389504-00	INNER CL.WASHER	1
51	145343-01	CLAMP,OUTER BLD	1
52	145344-00	SCREW,SPECIAL	1
53	389501-01	SPRING	1
54	N025950	LOWER GUARD	1
55	389572-00	LEVER	1
56	388496-03	RETAINING RING	1
57	98128-90	CARRIAGE BOLT	1
60	N035992	SHOE ASSEMBLY	1
68	N051399	NAMEPLATE	1
74	384127-01	SCREW	4
75	144803-00	RING,RET.	1
76	610744-00	ACORN NUT	1
78	389549-00	IDENT. LABEL	1
80	638063-00	KNOB	1
82	657027-00	WASHER	1

Parts List for DW366-BR Type 1

Item Number	Part Number	Description	Qty Required
83	N038133	BOLT	1
103	N035355	WRENCH	1
800	429698-00	GREASE:4 LB CAN	1