

861

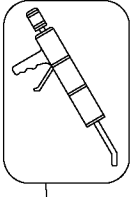

800

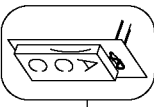

856

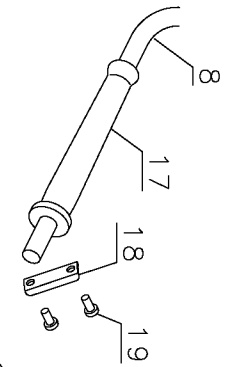

8

17

18

19

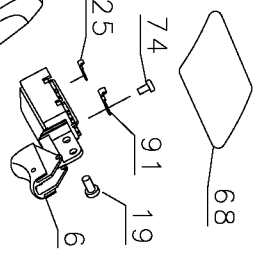

68

20

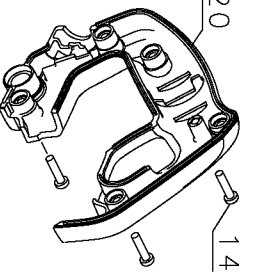

14

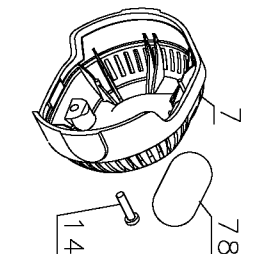

7

78

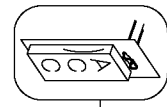

856

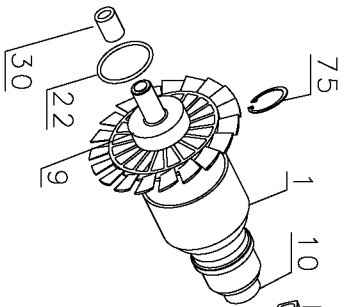

75

1

10

30

22

9

28

26

2

4

5

3

16

15

14

24

13

12

28

2

4

5

3

16

15

14

24

13

12

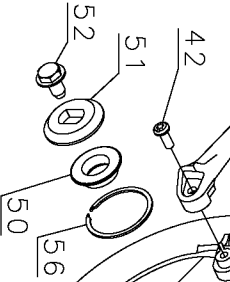

55

42

51

52

50

56

54

53

47

44

40

38

48

49

31

76

33

35

36

39

103

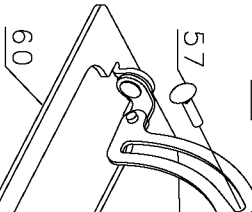

60

57

83

29

82

80

82

80

80

Parts List for DW366-B3 Type 1

Item Number	Part Number	Description	Qty Required
1	389530-04S	ARMATURE & BRGS	1
2	5140117-11	FIELD	1
3	N032830	BRUSH & LEAD	2
4	N065058	BRUSH RING ASM	1
5	398943-00	TORSION SPRING	2
6	389524-00	SWITCH	1
7	389510-00	END CAP	1
8	N037751	CORD & PLUG	1
9	605040-27	BALL BEARING	1
10	330003-60	BEARING	1
12	330019-15	SCREW	1
13	389553-00	HANDLE	1
14	330019-13	SCREW,M4X19	9
15	389511-01	FIELD CASE	1
16	145312-00	PLUG,RUBBER	1
17	330005-02	PROTECTOR, CORD	1
18	381065-00	CORD CLAMP	1
19	330019-10	SCREW	3
20	389519-01	HANDLE COVER	1
22	701297-00	O RING	1
24	330045-21	SCREW	3
25	053650-00	TERMINAL	2
26	330019-30	SCREW	2
28	389507-00	BAFFLE	1
29	389562-00	PIN	1
30	330004-06	BEARING,NEEDLE	1
31	N036345	UPPER GUARD ASSY	1

Parts List for DW366-B3 Type 1

Item Number	Part Number	Description	Qty Required
33	145347-00	LEVER,LOCK	1
35	152211-00	RING,RETAINING	1
36	389506-00	SPRING	1
38	389563-00	FELT SEAL	1
39	612472-00	SPINDLE LOCK	1
40	647099-00	O-RING	1
42	098094-13	SCREW	1
44	648222-01SV	SPINDLE & GEAR ASSY.	1
47	647098-00	SHOLDER SCREW	3
48	381066-00	BUMPER	1
49	381075-00	SHOULDER SCREW	1
50	389504-00	INNER CL.WASHER	1
51	145343-01	CLAMP,OUTER BLD	1
52	145344-00	SCREW,SPECIAL	1
53	389501-01	SPRING	1
54	N025950	LOWER GUARD	1
55	389572-00	LEVER	1
56	388496-03	RETAINING RING	1
57	98128-90	CARRIAGE BOLT	1
60	N035992	SHOE ASSEMBLY	1
68	N051398	NAMEPLATE	1
74	384127-01	SCREW	4
75	144803-00	RING,RET.	1
76	610744-00	ACORN NUT	1
78	389549-00	IDENT. LABEL	1
80	638063-00	KNOB	1
82	657027-00	WASHER	1

Parts List for DW366-B3 Type 1

Item Number	Part Number	Description	Qty Required
83	N038133	BOLT	1
103	N035355	WRENCH	1
800	429698-00	GREASE:4 LB CAN	1
856	B7254524-10	7-1/4 24T BLADE	1
861	N044228	KITBOX	1