

d25mha Blower UT-08086 - Carburetor And Fuel Tank

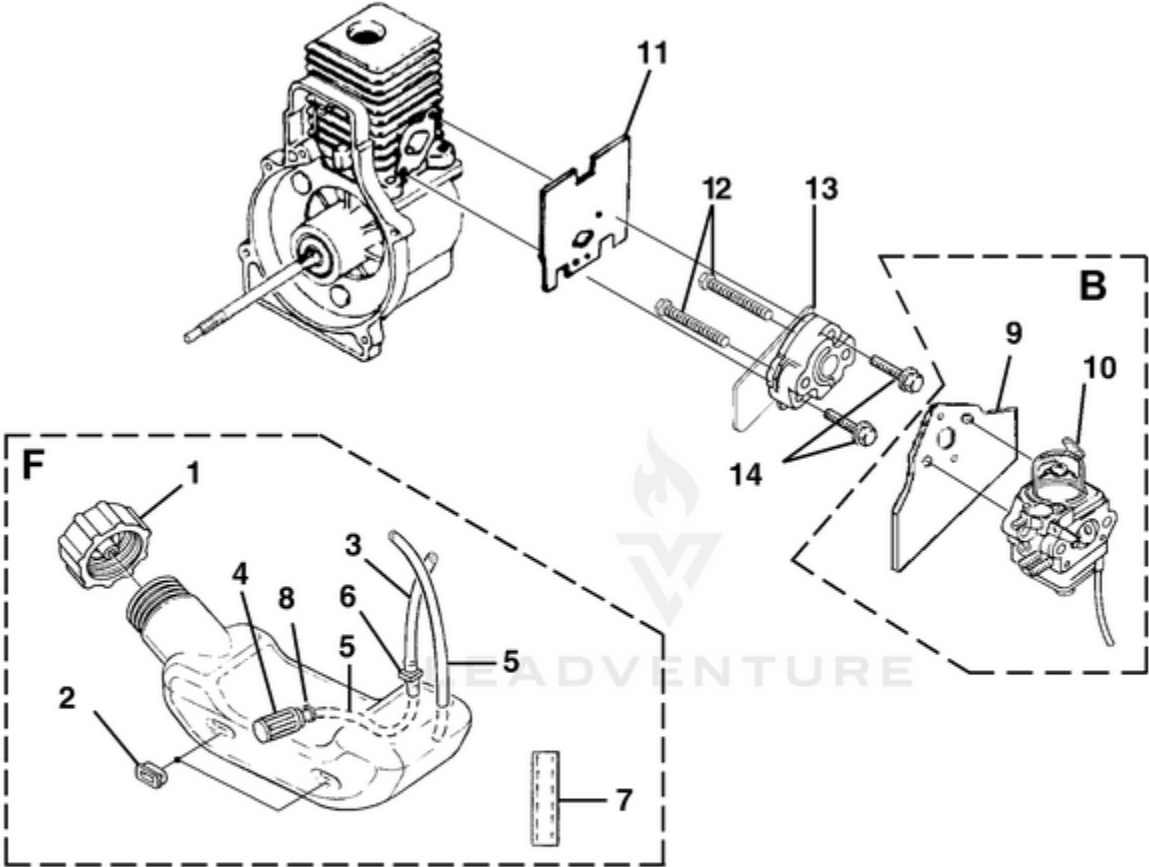

TORQUE SPECIFICATIONS			
Item No.	In/Lbs	Nm	Required Loctite
12	30-40	3.4-4.5	
14	40-50	4.5-5.6	262 Red

Rendered by LeadVenture, Inc.

Ref #	Part #	Description	Qty	Context Note
F	UP00136A	FUEL TANK KIT	1	Includes Items 1-8
1	AO9116	FUEL CAP (1 5/8" Opening)	1	
2	98792	BUMPER-Rubber	3	
3	0143922	TUBING-Rubber (5.5")	1	
4	PSO3380	FUEL FILTER	1	
5	9477225	TUBING-Rubber (6 1/4")	2	
6	07332	Fitting, Inlet	1	(small for 2.5mm ID fuel line)
	02067	Fitting, Inlet	1	(large for 3mm ID fuel line)
7	4283309	INSULATION-Tubing	1	
8	98268	CLAMP	1	
	06443A	GASKET-Crankcase	1	(Not shown)
	PS01565	SCREW, Sems (10-24 x .56)	4	(Not Shown)
B	UP00010A	CARBURETOR KIT	1	Includes Items 9-10
9	987661	GASKET-Carburetor	1	Also included with Cylinder Kits
10	UP03943	LEVER-Choke	1	(Walbro WT419,WT469)
B	UP00652	CARBURETOR KIT	1	Includes Items 9-10; (Back Packer(TM), BP250I, BP25175)
9	98766A	GASKET-Carburetor	1	Also included with Cylinder Kits
10	UP03943	LEVER-Choke	1	(Walbro WT419,WT469)
11	00775A	GASKET-Heat Dam	1	Also included with Cylinder Kits
12	04474	CARB. BOLT	2	
13	98768A	HEAT DAM	1	
14	093221	USE 660662001	2	

d25mha Blower UT-08086 - Engine Internal

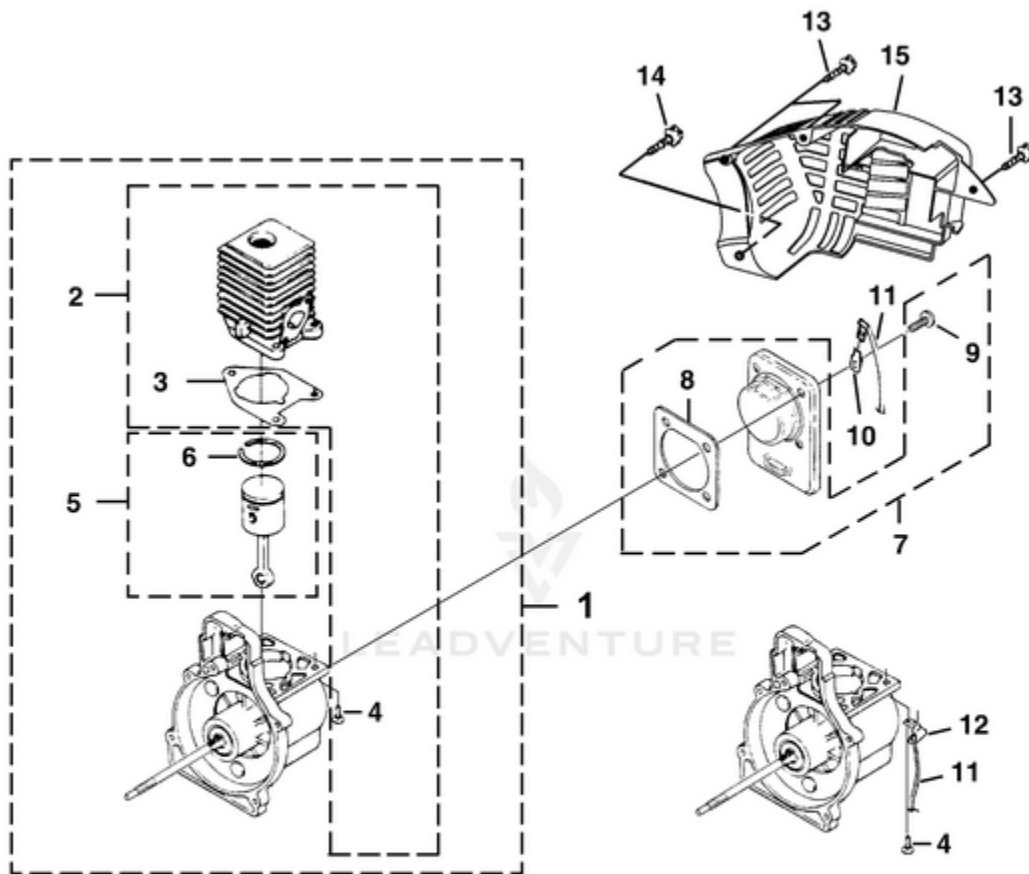

TORQUE SPECIFICATIONS			
Item No.	In/Lbs	Nm	Required Loctite
4	55-65	6.2-7.3	262 Red
9	55-65	6.2-7.3	262 Red
13	8-12	.9-1.4	
14	20-30	2.3-3.4	

Rendered by LeadVenture, Inc.

Ref #	Part #	Description	Qty	Context Note
1	UP03369A	SHORT BLOCK (25cc)	1	Includes Items 2-9
2	UP04136A	25 CC CYLINDER KIT	1	Includes Items 3-4
3	04388B	GASKET-Cylinder	1	
	00394B	GASKET-Muffler	1	(Not Shown)
	00775A	GASKET-Heat Dam	1	(Not Shown)
4	PS02807	SCREW, SEMS (12-24 x 3/4)	3	
5	984544001	25 CC PISTON & ROD	1	Includes Item 6
6	PS01359	RING-Piston	1	
7	PS02130	CRANKCASE COVER-Stamped Steel	1	Includes items 8-9
8	06443A	GASKET-Crankcase	1	Also included with Cylinder Kits.
9	PS01565	SCREW, SEMS (10-24 x .56)	4	
10	02851	TAB-Male	1	
11	PA00666	CABLE-Throttle w/Ignition Leads	1	(Back Packer(TM), BP250I, BP25175)
12	A01767	CABLE BRACKET	1	(Back Packer(TM), BP250I, BP25175)
13	82376	SCREW-Thread Form. (#8 X 1/2")	3	
14	82563	SCREW-Thread Form. (#10 X 3/4")	1	
15	UP06522A	SHROUD	1	

d25mha Blower UT-08086 - Ignition With Rotor

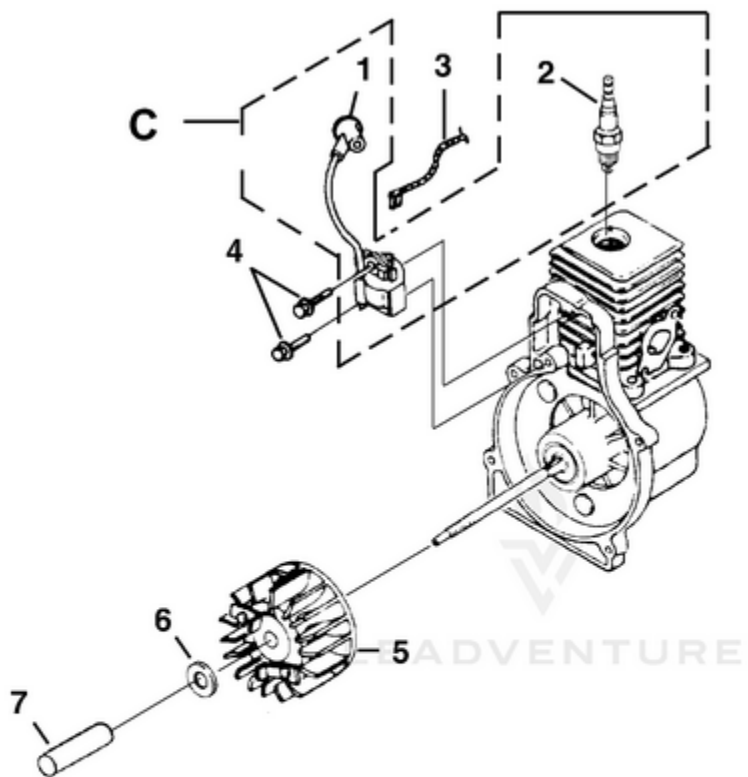

TORQUE SPECIFICATIONS			
Item No.	In/Lbs	Nm	Required Loctite
2	120-180	13.6-20.3	
4	30-40	3.4-4.5	242 Blue

Rendered by LeadVenture, Inc.

Ref #	Part #	Description	Qty	Context Note
C	UP06784	IGNITION KIT w/ Module	1	Includes items 1-2
1	UP03868	TERMINAL-Hi-Tension	1	
2	PSO2227	SPARK PLUG (RDJ-7Y)	1	(Back Packer(TM), BP250I, BP25175)
3	PA00666	CABLE-Throttle w/Ignition Leads	1	
4	82540	SCREW-Thread Form. (8-32 x 1")	2	
5	984531001	ROTOR & STARTER PAWLS	1	
6	95479A	WASHER-Flat	1	
7	PSO3566	SPACER-Fan	1	

d25mha Blower UT-08086 - Muffler And Air Cleaner

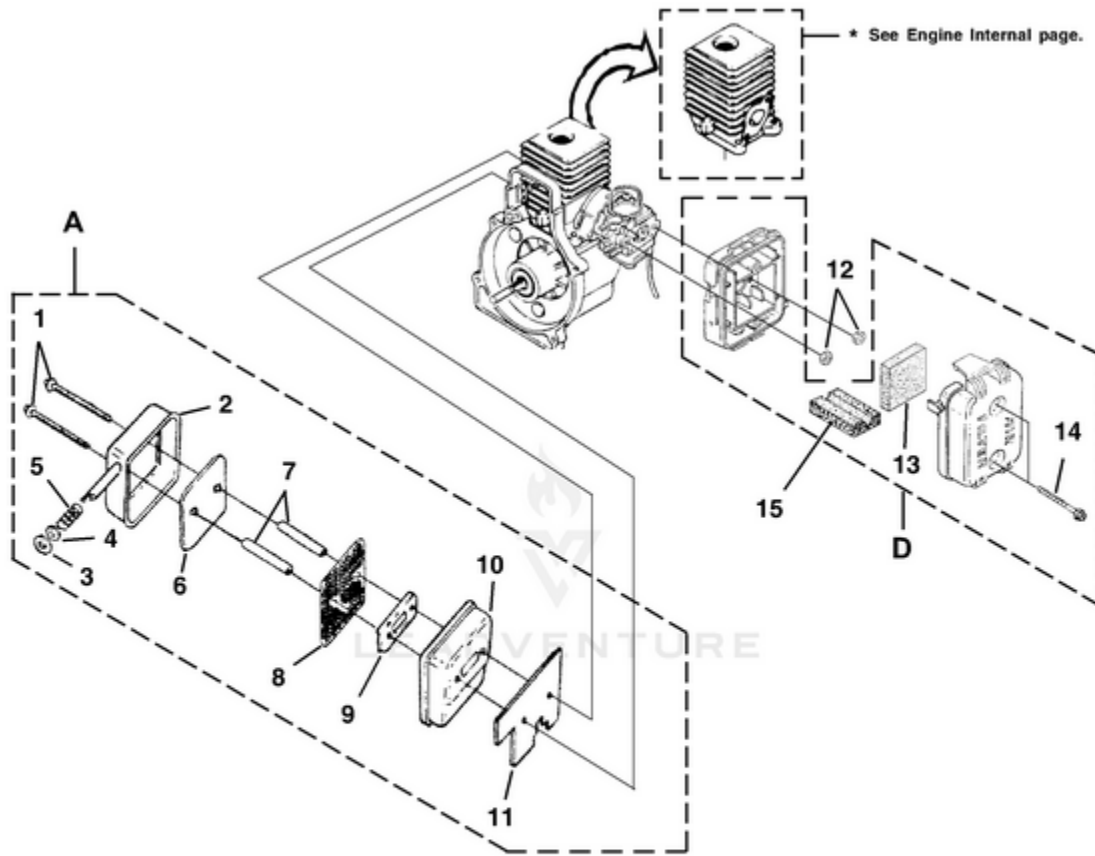

TORQUE SPECIFICATIONS			
Item No.	In/Lbs	Nm	Required Loctite
1	40-50	4.5-5.6	
12	30-40	3.4-4.5	
14	30-40	3.4-4.5	

Rendered by LeadVenture, Inc.

Ref #	Part #	Description	Qty	Context Note
A	PA01181	MUFFLER-Complete	1	Includes Items 1-11
1	88060	SCREW-Sems Hex Hd. (10-24 x 2 1/2")	2	
2	A00366	MUFFLER COVER	1	
3	00381	WASHER-Insulating	1	
4	84117	WASHER-Flat	1	
5	00387	SPRING-Compression	1	
6	00777	DEFLECTOR-Muffler	1	
7	04785	SPACER-Muffler	2	
8	00388B	SCREEN-Spark Arrestor	1	
9	98783	PLATE-Reinforcing	1	
10	98781	BODY-Muffler	1	
11	00394B	GASKET-Muffler	1	Also included with Short block & Cylinder Kits.
12	81208	NUT-Hex (10-24)	2	
D	UP00011	AIR FILTER KIT	1	Includes items 13-14
13	98760	AIR FILTER	1	
14	093221	USE 660662001	2	
15	04857	FOAM AIR FILTER	1	Not Used on UT08111 and UT08111A

d25mha Blower UT-08086 - Starter

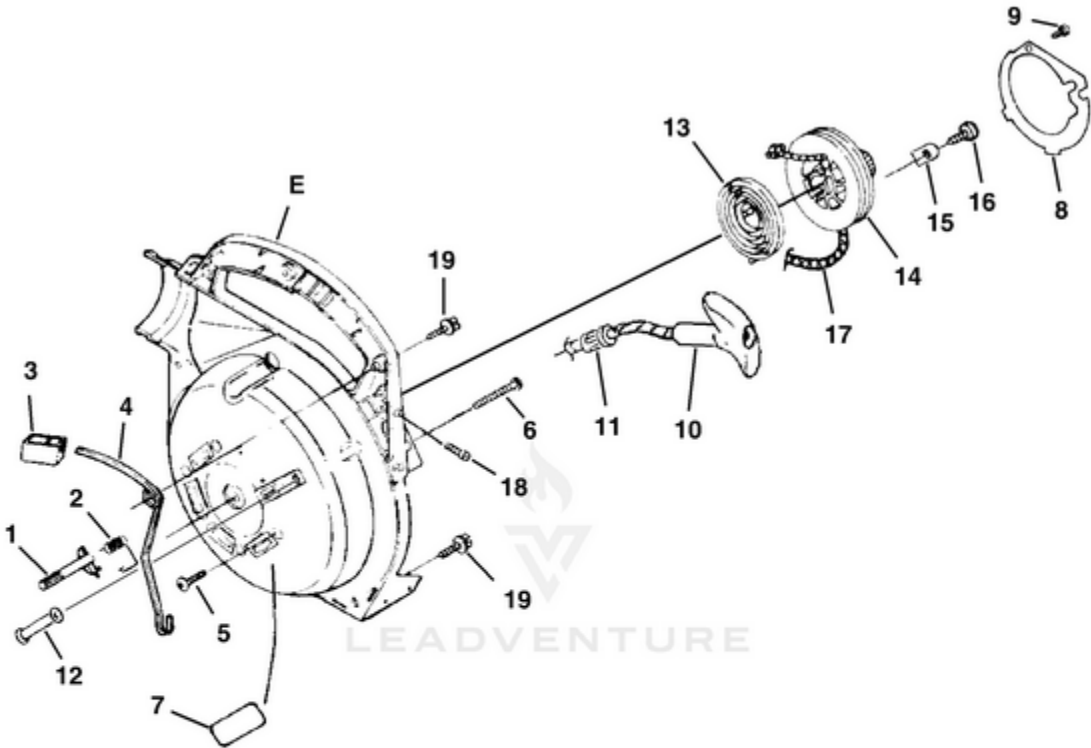

TORQUE SPECIFICATIONS			
Item No.	In/Lbs	Nm	Required Loctite
5	55-60	6.2-6.8	
6	20-30	2.3-3.4	
9	8-12	9-1.4	
16	30-40	3.4-4.5	
18	20-30	2.3-3.4	
19	20-30	2.3-3.4	

Rendered by LeadVenture, Inc.

Ref #	Part #	Description	Qty	Context Note
1	00368A	LATCH-Throttle	1	Not Used on UT08111 and UT08111A
2	00370	SPRING-Throttle Latch	1	Not Used on UT08111 and UT08111A
3	00367	TRIGGER-Throttle	1	Not Used on UT08111 and UT08111A
4	00369A	LEVER-Throttle	1	Not Used on UT08111 and UT08111A
5	82538	SCREW-Thread Form. (10-24 X 3/4")	4	
6	JA416903	SCREW-Thread Form. (#10 X 1 5/8")	1	
E	UP06792A	VOLUTE HOUSING & STARTER	1	Includes items 7-17
7	UP03822A	KIT-Sealing	1	Not Used on UT08111 and UT08111A
8	00374	PLATE-Rotor	1	
9	82528	SCREW-Thread Form. (#6 X 1 3/8")	1	
10	5946702	GRIP-Starter (Yellow)	1	Not Used on UT08111 and UT08111A
	PSO1200	GRIP-Starter (Yellow)	1	
11	969811A	BUSHING-Starter	1	
12	00364B	GUIDE-Starter Rope	1	
13	A98773A	SPRING & CONTAINER	1	
14	98770A	PULLEY-Starter	1	
15	98791	BRACKET-Retaining	2	
16	82541	SCREW-Thread Form. (#10 X 1/2")	2	
17	9789901	ROPE-Starter	1	
18	PS82146	SCREW-Phil. Hd. (8-32 X 5/8")	1	Not Used on UT08111 and UT08111A
19	82563	SCREW-Thread Form. (10-24 X 3/4")	5	

d25mha Blower UT-08086 - Volute, Fan & Tubes

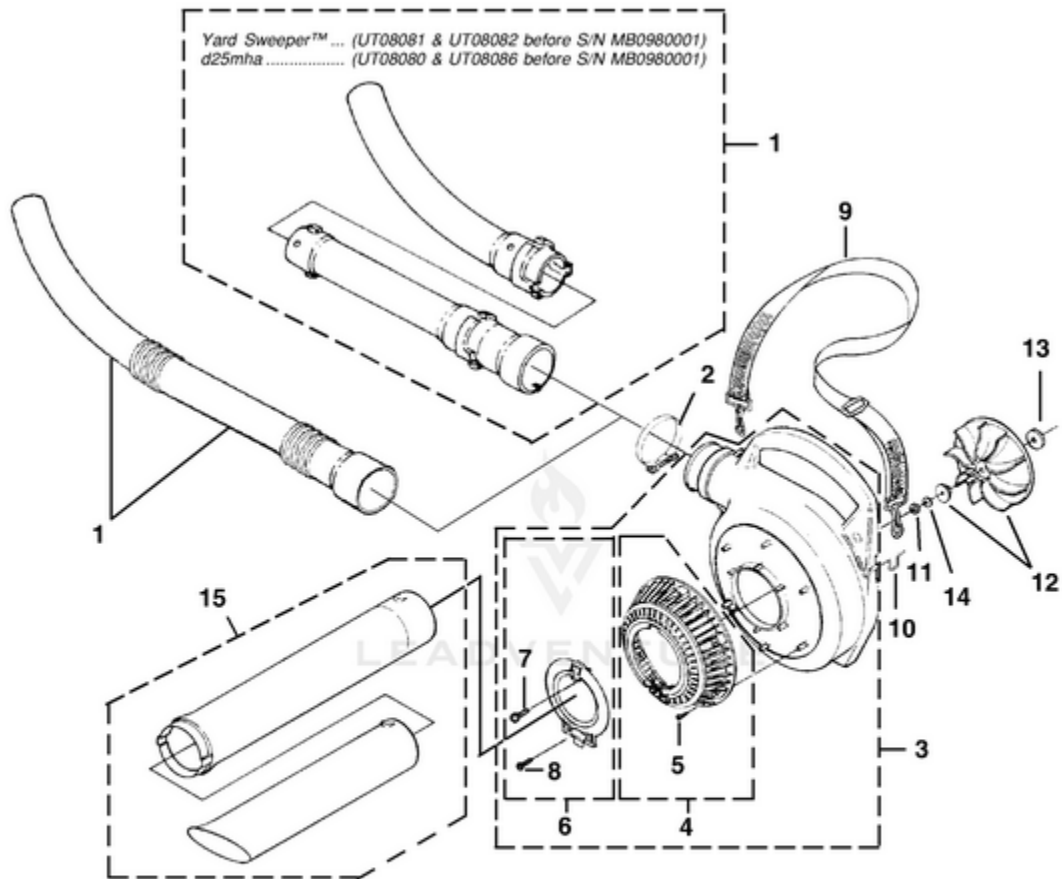

TORQUE SPECIFICATIONS			
Item No.	In/Lbs	Nm	Required Loctite
5	8-12	.9-1.4	
7	10-20	1.1-2.3	
8	8-12	.9-1.4	
11	130-150	14.7-16.9	

Rendered by LeadVenture, Inc.

Ref #	Part #	Description	Qty	Context Note
1	984917001	BLOWER TUBE KIT	1	
2	00433B	CLAMP w/Fasteners	1	
3	984918001	VOLUTE HOUSING KIT	1	Includes Items 4-8
4	UP06720A	BLOWER VAC GRILLE KIT	1	Includes Item 5
5	82528	SCREW-Thread Form. (#6 X 3/8")	6	
6	984910001	ACCESS DOOR KIT	1	Includes Items 7-8
7	82312	SCREW-Thread Rolling (#10 X 5/8")	1	
8	82376	SCREW-Thread Form. (#8 X 1/2")	1	
9	96337C	SHOULDER STRAP	1	
10	00398	WIRE LOOP	1	
11	81124A	NUT-Hex (3/8-24)	1	
12	UP06826A	BLOWER FAN KIT	1	
13	03165	WASHER-Flat	2	
14	03163	WASHER-Bellville (3/8")	1	
15	UP06705A	VACCUM TUBE KIT	1	(Vacuum units only)