

CG5200 Generator UT-03794 - Brush Head - Generator

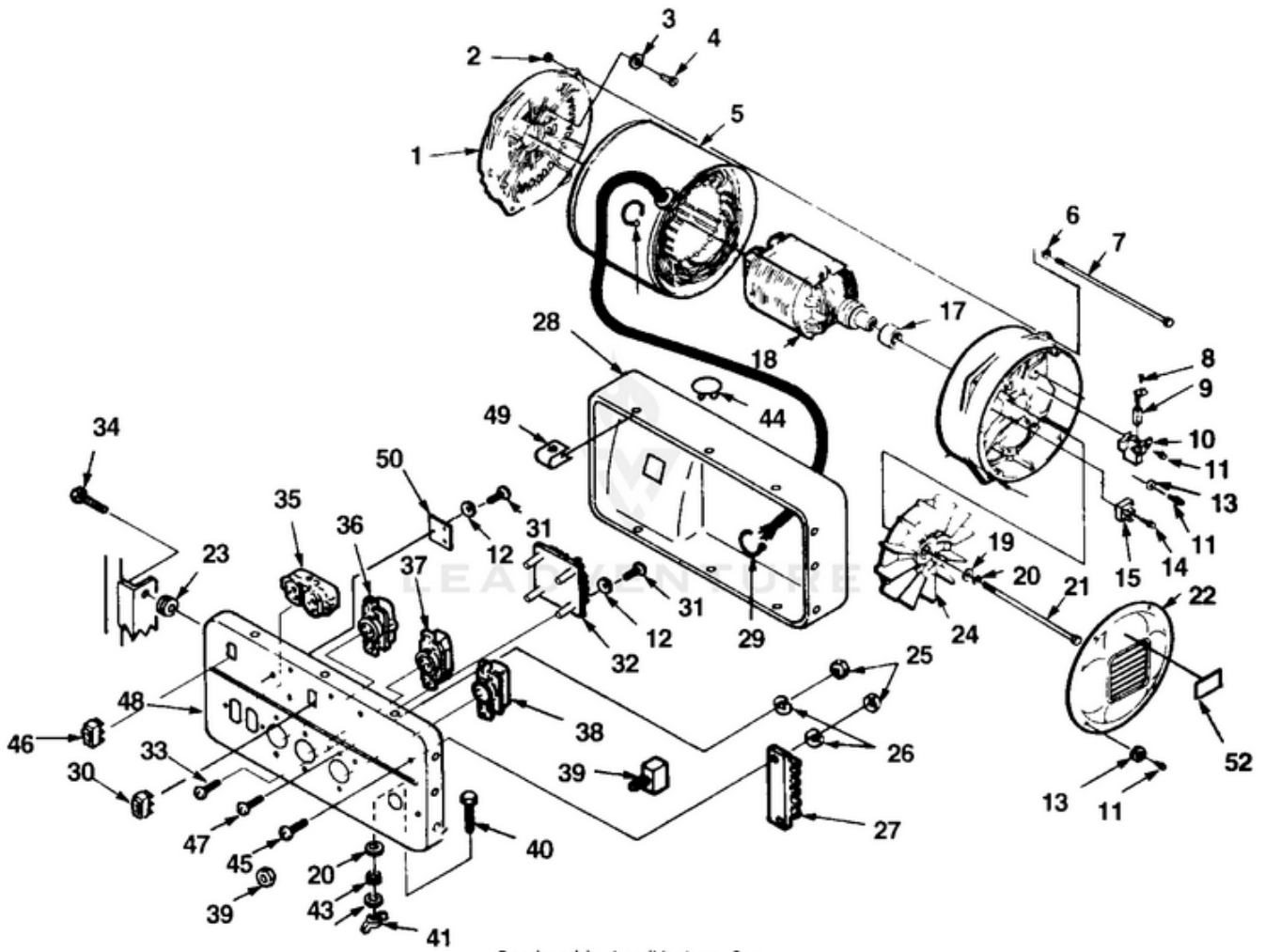

Rendered by LeadVenture, Inc.

Ref #	Part #	Description	Qty	Context Note
1	5375226	END BELL	1	
2	81053	NUT-Hex (1/4-20)	4	
3	83117	WASHER-Lock	4	
4	PS80187	SCREW-Hex Hd (3/8-16 X 7/8")	4	Torque Specs: 240-250 In/Lbs, 27.1-28.2, Required Loctite Red 277 Nm
5	A49330S	STATOR SHELL	1	
6	83070	WASHER-Lock/Int (1/4")	4	
7	4885304	BOLT-Stator	4	
8	80260	SCREW-Mach Pan Hd (8-32 X 3/8")	2	Torque Specs: 5-7 In/Lbs, .6-.8 Nm
9	53762	BRUSH	2	
10	53760	BRUSH HOLDER	1	
11	82474	SCREW-Thread Rolling (8-32 X 1/2")	7	Torque Specs: 18-22 In/Lbs, 2.0-2.5 Nm
12	84025	WASHER-Flat (#8)	7	
13	83022	WASHER-Lock (#8)	5	
14	82205	SCREW-Hex Tap (8-32 X 3/4")	1	Torque Specs: 18-22 In/Lbs, 2.0-2.5 Nm
15	53818A	RECTIFIER	1	
16	491844	BRUSH HEAD	1	
17	53819	BEARING	1	
18	A49095S	ROTOR	1	
19	84058	WASHER-Flat (5/16)	1	
20	83002	WASHER-Lock (5/16)	2	
21	4885209	BOLT-Rotor	1	
22	513941A	BRUSH HEAD COVER	1	
23	49351	GROMMET	4	
24	A53769	FAN	1	
25	81009	NUT-Hex (8-32)	10	
26	83060	WASHER-Lock (#8)	10	
27	42366	BLOCK-Terminal	1	
28	A49271	PANEL-Cover	1	
29	PS46840	CABLE TIE	A/ R	
30	49569	SWITCH (DPDT)	1	
31	80577	SCREW-Pan Hd (#8-32 X 1/2")	7	Torque Specs: 8-10 In/Lbs, 1.4-1.6 Nm
32	A06289	VOLTAGE REGULATOR	1	
33	82596	SCREW-Plastite (8-16 x 1")	4	Torque Specs: 12-14 In/Lbs, 1.4-1.6 Nm
34	49748	SCREW-Shoulder	4	
35	A08633	RECEPTACLE, GFCI (Nema 5-15R)	1	
36	48978	RECEPTACLE-Locking (Nema L5-20R)	1	
37	42601	RECEPTACLE-Locking (Nema L5-30R)	1	
38	46508	RECEPTACLE-Locking (Nema L14-20R)	1	
39	48952	CIRCUIT BREAKER-2 5 Amp	1	

Ref #	Part #	Description	Qty	Context Note
40	82598	SCREW-Hex Hd (5/16-18 X 1")	1	
41	81015	NUT-Wing (5/16-18)	1	Torque Specs: Hand Tight
42	83081	WASHER-Lock (5/16)	1	
43	81018	NUT-Hex (5/16-18)	1	
44	49368	CLAMP-Cable	1	
45	80582	SCREW-Pan Hd (8/32 X 5/8")	2	Torque Specs: 12-14 In/Lbs, 1.4-1.6 Nm
46	49299	SWITCH-Rocker	1	
47	80577	SCREW-Machine Pan (8-32 X 3/8")	23	Torque Specs: 12-14 In/Lbs, 1.4-1.6 Nm
48	A02208	CONTROL PANEL	1	
49	02191	DECAL-Schematic	1	
50	A01865A	IDLE CONTROL	1	
51	81227	NUT-Speed	8	
52	49613	DECAL-Warning	1	
	09181	CIRCUIT BREAKER (15 AMP)	1	
	09183	CIRCUIT BREAKER (20 AMP)	2	
	06692A	CIRCUIT BREAKER (30 AMP)	1	

CG5200 Generator UT-03794 - Roll Cage - Fuel Tank

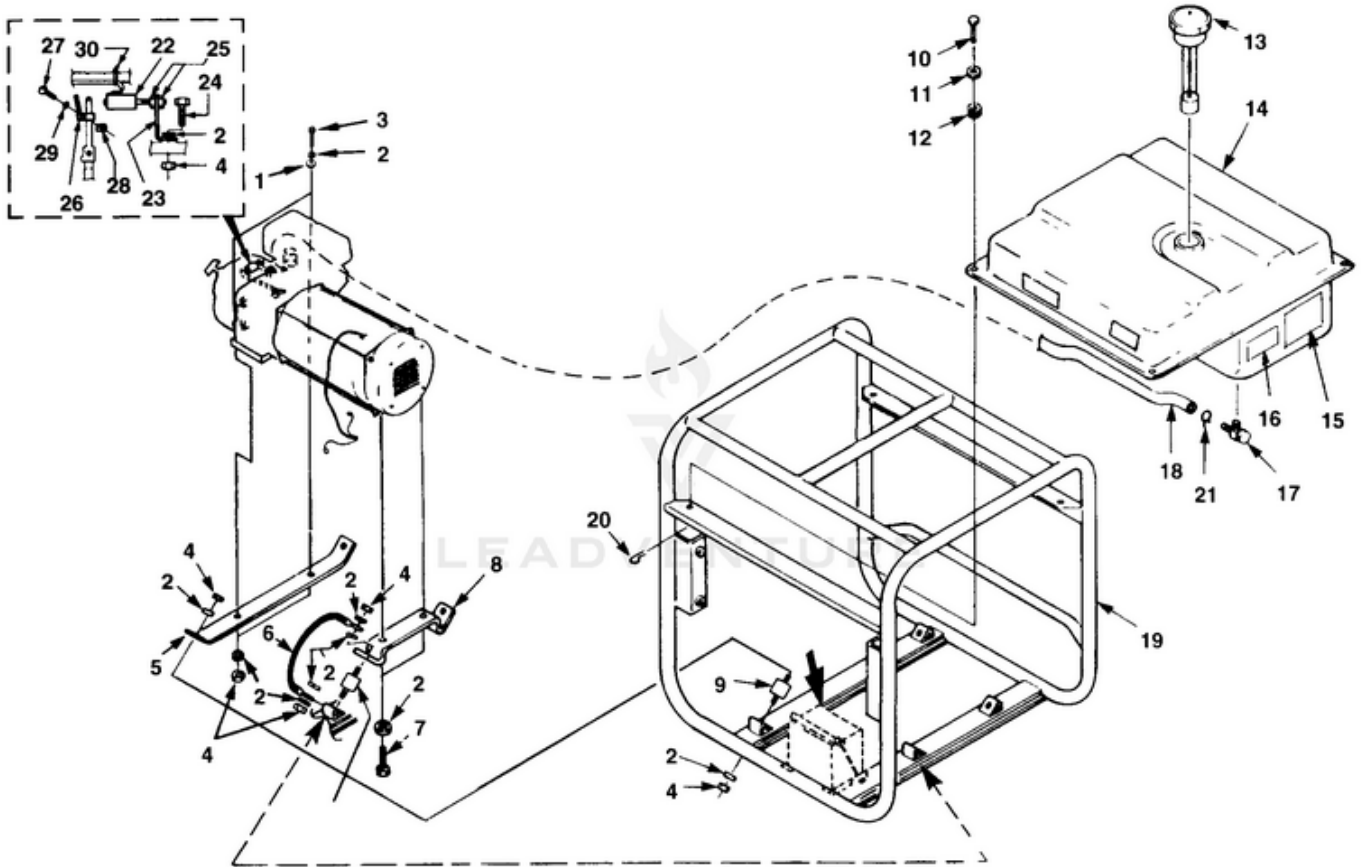

Rendered by LeadVenture, Inc.

Ref #	Part #	Description	Qty	Context Note
1	84046	WASHER-Flat (5/16)	1	
2	83081	WASHER-Lock/Int.	16	
3	80288	SCREW-Cap Hex Hd.	2	Torque Specs: 145-155 In/Lbs, 16.4-17.5 Nm
4	81162	NUT-Hex (5/16-18)	10	Torque Specs: 145-155 In/Lbs, 16.4-17.5 Nm
5	PS49265	SUPPORT-Engine	1	
6	A49399	GROUND-Strap	1	
7	82206	SCREW-Thread Form (5/16-18 X 1")	2	Torque Specs: 220-250 In/Lbs, 24.9-28.2 Nm
8	48944	SUPPORT-Generator	1	
9	PS49367	ISOLATOR-Vibration	4	
10	49329	PIN-Clevis	4	
11	84006	WASHER-Flat	4	
12	49351	GROMMET-Isolator	4	
13	49179	CAP-Fuel	1	
14	021101	TANK-Fuel	1	
15	49598	DECAL-Caution	1	
16	49340A	DECAL-Fuel Valve	1	
17	02192	VALVE-Fuel	1	
18	0216002	FUEL-Line	1	
19	A040601	ROLL CAGE	1	
20	49412	PIN-Cotter Hair	4	
21	02181	HOSE-Clip	2	
22	A02233	ELECTROMAGNET	1	
23	02174	BRACKET-Magnet, 8HP	1	
24	82598	SCREW-Cap Hex Hd (5/16-18 X 1")	1	
25	810652	NUT-Hex	2	Torque Specs: 25 In/Lbs, 2.8 Nm
26	02172	PADDLE-8HP & 11HP	1	
27	80577	SCREW-Machine Pan Hd (8-32 X 3/8")	1	Torque Specs: 10-15 In/Lbs, 1.1-1.7 Nm
28	81227	NUT-Speed	1	
29	83022	WASHER-Lock/Int	1	
30	JA994274	TIE-Cable	2	

CG5200 Generator UT-03794 - Schematic

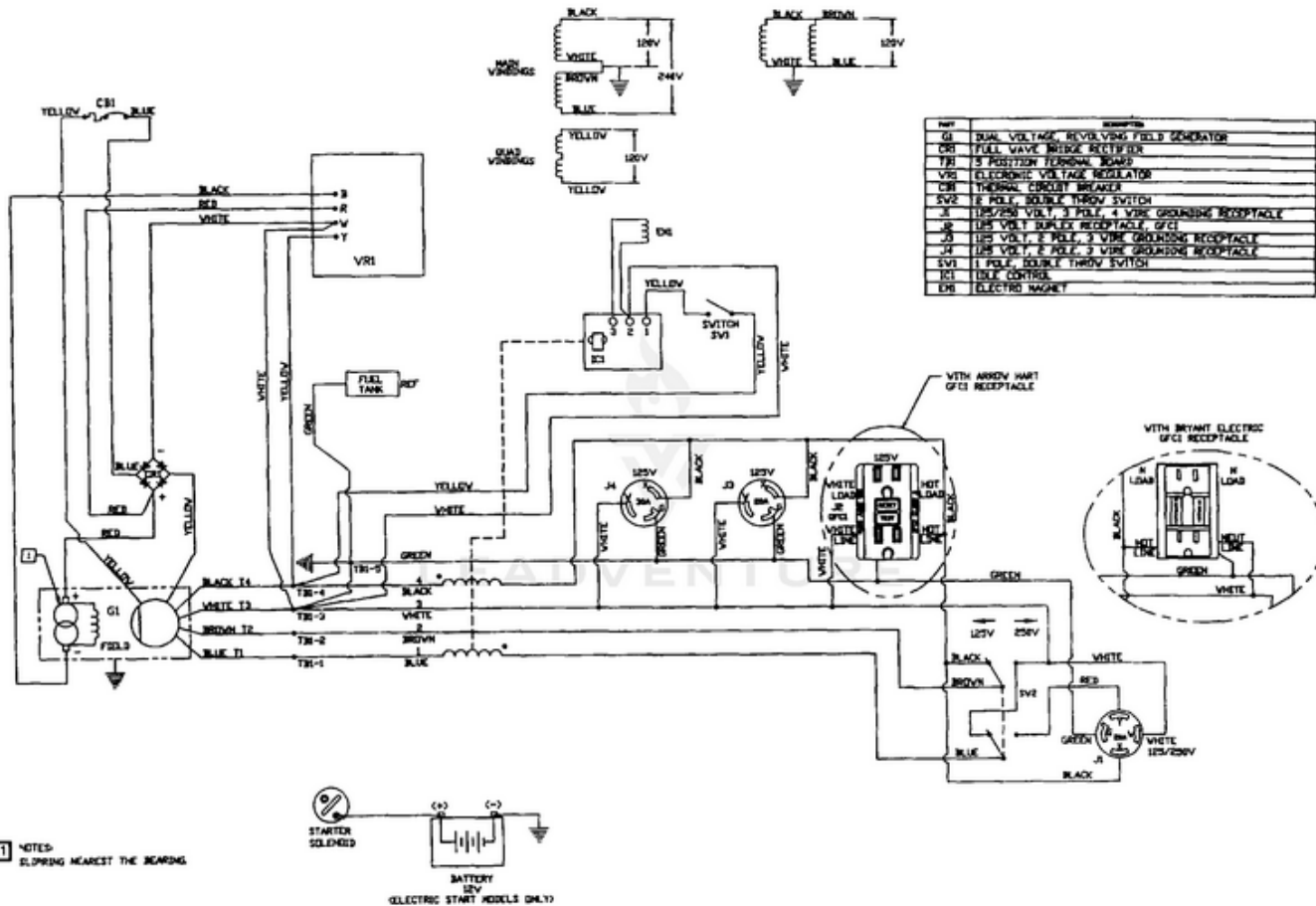

Rendered by LeadVenture, Inc.