

CUTTING SAW

C-306C, C-355C

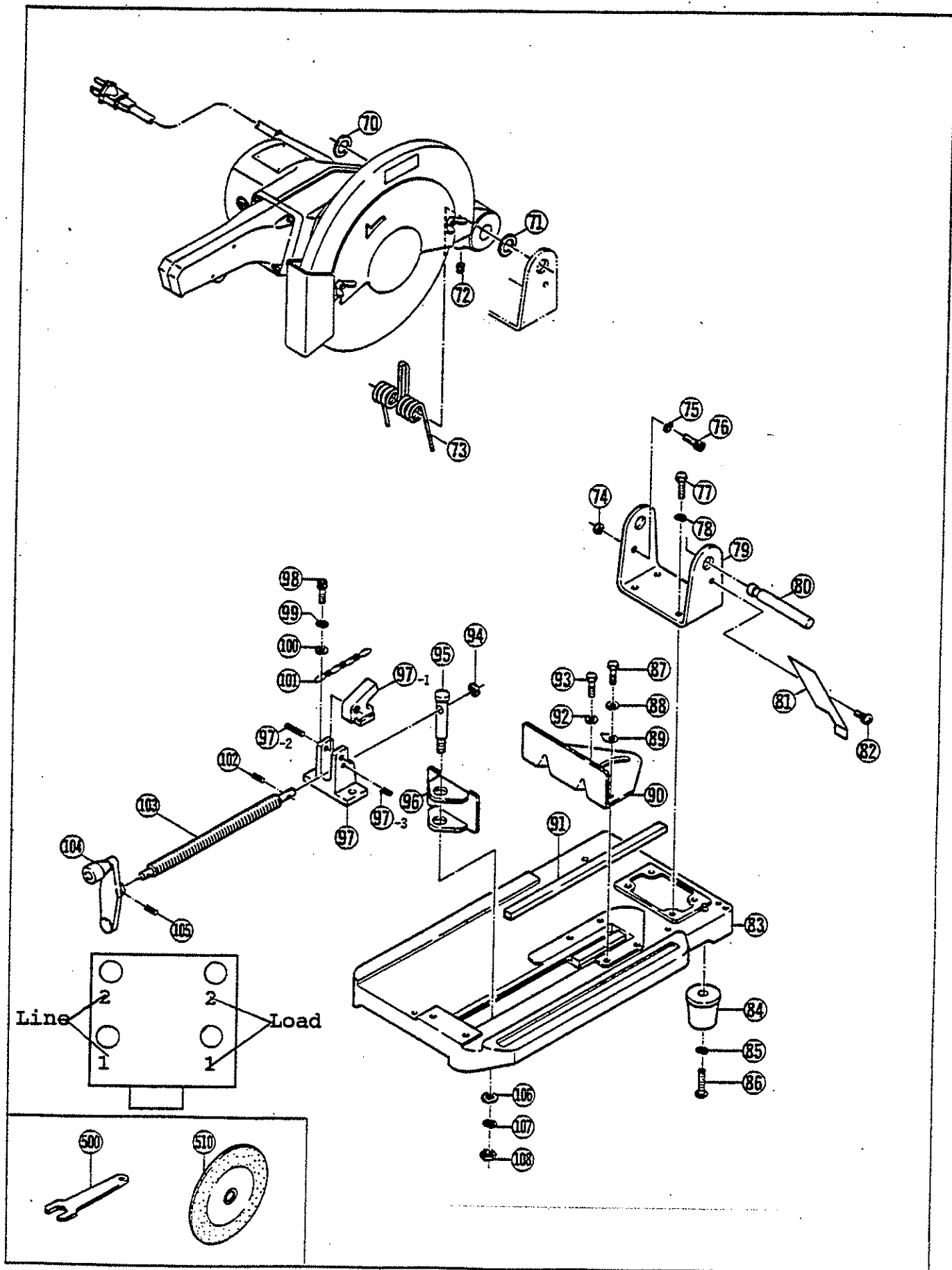

PARTS LIST FOR AFTER SALES SERVICE

MODEL C306C, C355C

REF	PART NO.	DESCRIPTION	QTY	REF	PART NO.	DESCRIPTION	QTY
	9020508	PHILLIPS PAN SCREW M5X8	2	56	6900120	COLLAR	1
	6800332	TAIL COVER	1	57	6940090	OUTER FLANGE	1
3	9280508	CLAMP SCREW M5X8	2	58	9571000	WASHER	1
4	6570097	BRUSH HOLDER	2	59	9191020	HEX HEAD BOLT M10X20	1
5	6540063	CARBON BRUSH SET	1	60	6880191	SAFETY COVER	1
6	6570107	BRUSH CAP	2	61	9240610	WING BOLT M6X10	2
7	9610400	SPRING WASHER M4	1	70	6900140	THRUST WASHER	1
8	9040408	TAPPING SCREW (S) M4X8	1	71	6900140	THRUST WASHER	1
9	6360038	BUSH	1	72	9290508	CLAMP SCREW M5X8	2
10	9060410	TAPPING SCREW (B) M4X10	1	73	6180034	TORSION SPRING C306C	1
11	6550450	TRIGGER SWITCH	1	--	6180036	TORSION SPRING C355C	1
12	6830239	HANDLE (A)	1	74	9300800	HEX NUT M8	1
13	9020625	PHILLIPS PAN SCREW M6X25	3	75	9550800	SPRING WASHER M8	1
14	6290008	HOOK	1	76	9190815	HEX HEAD BOLT M8X15	1
15	9020625	PHILLIPS PAN SCREW M6X25	1	77	9191025	HEX HEAD BOLT M10X25	4
16	6830245	HANDLE (B)	1	78	9551000	SPRING WASHER M10	4
17	9060420	TAPPING SCREW (B) M4X20	3	79	6150251	HINGE	1
18	6910535	NAME PLATE C306C	1	80	6100037	CENTER SHAFT	1
--	6910533	NAME PLATE C355C	1	81	6880172	DUST COVER	1
19	6120005	RIVET #2	4	82	9020408	PHILLIPS PAN SCREW M4X8	3
20	9130516	PHILLIPS OVAL SCREW M5X16	2	83	6850062	BED	1
21	6150245	WASHER	2	84	6370028	FOOT	4
22	6830225	AUX. HANDLE	1	85	9570600	WASHER	4
23	6520234	CORD ASS'Y AWG#14X3X2	1	86	9040635	TAPPING SCREW (S) M6X35	4
24	6560058	CORD HOLDER	1	87	9191025	HEX HEAD BOLT M10X25	1
25	6690086	CORD CLAMP	1	88	6900123	COLLAR	1
26	9040410	TAPPING SCREW (S) M4X10	1	89	6950045	GRADUATION PLATE	1
27	6360038	BUSH	1	90	6150248	WISE	1
28	6800274	MOTOR HOUSING	1	91	6960010	GUIDE BAR	2
29	6500269	FIELD COIL	1	92	9571000	WASHER	1
30	6150260	PLATE	1	93	9191025	HEX HEAD BOLT M10X25	1
32	9020570	PHILLIPS PAN SCREW M5X70	2	94	9571000	WASHER	1
33	6090047	FAN CASING	1	95	6100043	CLAMP SHAFT	1
34	969235005	BALL BEARING #6200LLB	1	96	6150272	CLAMPER	1
35	6030268	ARMATURE	1	97	6090226	QUICK VISE (BEFORE 2/90)	1
36	969235005	BALL BEARING #6200LLB	1	97	6090048	QUICK VISE (AFTER 2/90)	1
37	6120062	STOPPER PIN	1	97-1	6830247	LEVER (BEFORE 2/90)	1
38	6180035	COMPRESSION SPRING	1	97-1	6830248	LEVER (AFTER 2/90)	1
39	6820144	GEAR CASE C306C	1	97-2	9405040	SPRING PIN (BEFORE 2/90)	1
--	6820153	GEAR CASE C355C	1	97-2	9405030	SPRING PIN (AFTER 2/90)	1
40	969377002	BALL BEARING #6000LLB	1	97-3	9402016	SPRING PIN (BEFORE 2/90)	1
41	6100224	PARALLEL KEY	1	97-3	9402010	SPRING PIN (AFTER 2/90)	1
42	6110038	GEAR SHAFT	1	98	9220825	HEX SOCKET HEAD BOLT M8X25	2
43	6200034	FINAL GEAR C306C	1	99	9550800	SPRING WASHER M8	2
--	6200035	FINAL GEAR C355C	1	100	9560800	WASHER	4
44	6900122	COLLAR	1	101	6290010	CHAIN	1
45	971803001	BALL BEARING #6203LLB	1	102	9403018	SPRING PIN	1
46	6820145	GEAR CASE COVER C306C	1	103	6100044	CLAMP SHAFT	1
--	6820154	GEAR CASE COVER C355C	1	104	6831455	HANDLE	1
47	9040512	TAPPING SCREW (S) M5X12	2	105	9404018	SPRING PIN	1
48	6920181	"RYOBI" MARK C306C	1	106	9571200	WASHER	1
--	6920182	"RYOBI" MARK C355C	1	107	9551200	SPRING WASHER	1
49	6020036	SAFETY GUARD C306C	1	108	9301200	HEX NUT M12	1
--	6020048	SAFETY GUARD C355C	1	--	6530134	TIGHTENING BAND	1
50	6120014	RIVET #2	1	--	6530209	FASTEN CONNECTOR	1
51	6900132	COLLAR	1	--	6560026	TERMINAL	1
52	6880196	COVER C306C	1	--	6560037	TERMINAL	4
--	6880197	COVER C355C	1	--	6590113	VINYL TUBE	1
5	9020560	PHILLIPS PAN SCREW M5X60	4	--	6590114	VINYL TUBE	1
54	6900120	COLLAR	1	500	6240533	SINGLE END WRENCH 17	1
55	6940088	INNER FLANGE	1	510		*14 ABRASIVE WHEEL	1

SERVICE NOTES: REF: 97 SERIAL #43161
FEBRUARY 1990

* STANDARD HARDWARE ITEM