

Type: ASW 14-10 (without battery and angled head)
(14.4V)
Part no.: 71124209950

Item	Part no.	Designation	Quantity
10	31912105010	Motor housing	1
40	30703058000	Plug	1
50	54199056800	Motor 14,4V	1
60	30762433990	Electronics	1
70	30220065000	Pressure piece	1
80	30719845010	Connecting cable	1
90	30762377020	Foil conductor	1
100	32436074000	Flange	1
105	42443003043	Circlip M4	2
110	43075001030	Countersunk screw	2
125	30109196020	Planetary gear	1
130	32424025004	Cover	1
140	32424026000	Cover	1
150	30904043000	Leaf spring	1
160	32805221000	Switch pushbutton	1
180	32805220000	Switch pushbutton	1
200	30901379000	Spiral spring	1
210	32804003010	Slide switch	1
220	32816710000	Switch pushbutton	1
235	30508040010	Bush	1
250	30104139000	Tool holder	1
260	30103051001	Clutch ring	1
270	41708017002	Ball	9
280	30103052000	Clutch ring	1

Type: ASW 14-10 (without battery and angled head)
(14.4V)
Part no.: 71124209950

Item	Part no.	Designation	Quantity
290	41708018000	Ball	3
295	41708018000	Ball	12
300	30901377000	Spiral spring	1
315	32602092010	Pressure piece Set	1
340	40201022008	Straight pin	2
350	32436073000	Flange	1
360	42615090002	Circlip	1
380	42616033009	Circlip	1
395	32624192990	Disc Set	1
410	30101038000	Clutch part	1
420	30509048000	Thread ring	1
430	30501352000	Sleeve	1
440	43072015000	Screw	8
2500	32217517000	RFID Transponder VE1	1
5000	32123002006	Adjustment spanner - torque	1
5011	42615000004	Circlip	1
5020	30216171020	Bolt	1
5021	30216171000	Bolt	1
5022	30901410000	Spiral spring	1
5023	30218037000	Plug	1
5030	30217340015	Bolt	1
5031	30901360009	pressure spring	1
5032	30217340006	Bolt	1
5040	30102109010	Tool holder Set	1

Type: ASW 14-10 (without battery and angled head)
(14.4V)
Part no.: 71124209950

Item	Part no.	Designation	Quantity
5041	41708015005	Ball	1
5042	30503144002	Sleeve	1
5043	30901315002	Spiral spring	1
5044	32601242005	Ring	1
5045	42615081002	Circlip	1
9020	34130054061	Safety instruction	1

Type:
Part no.:

ASW 14-10 (without battery and angled head) (14.4V)
71124209950

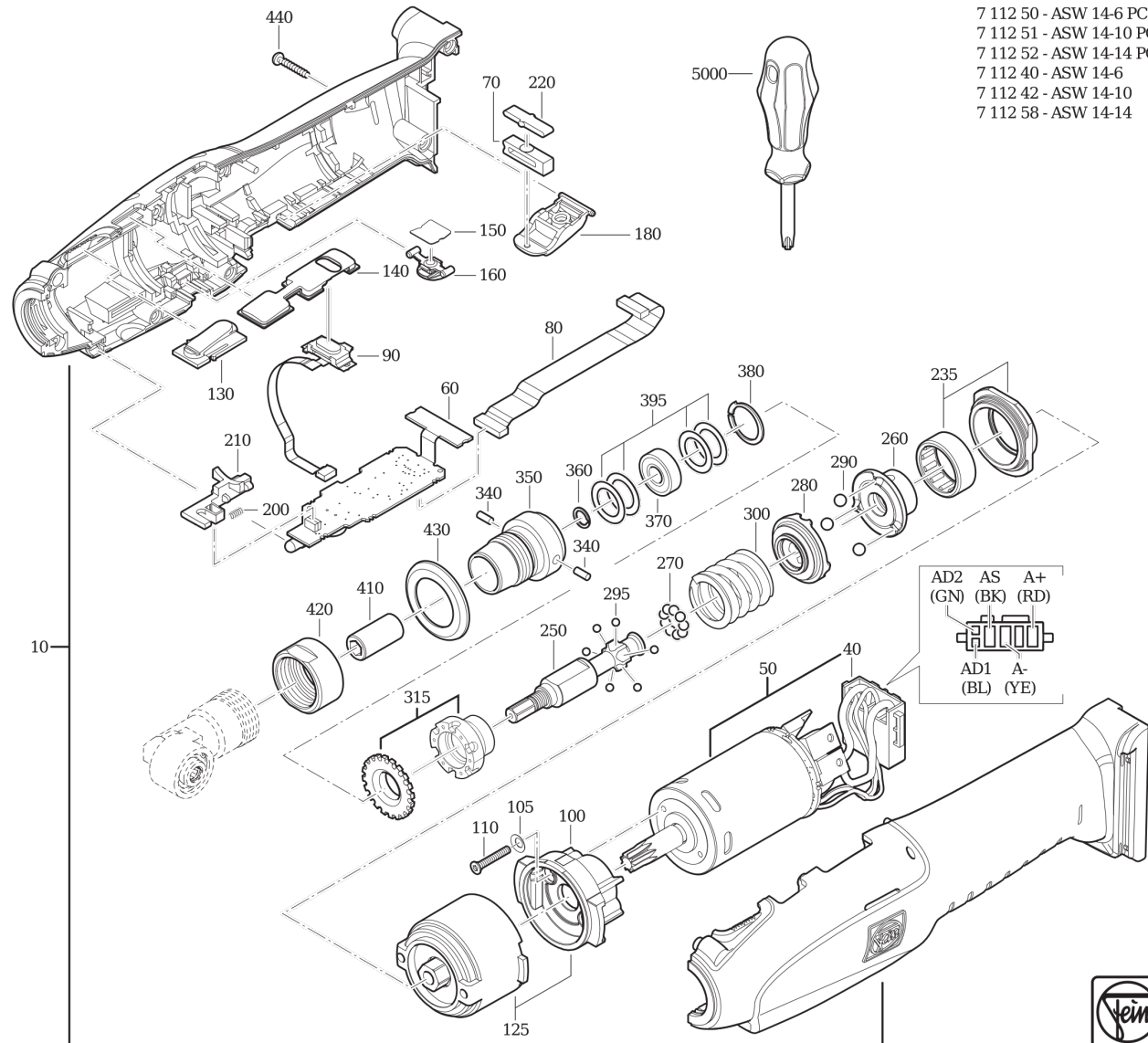

Type:
Part no.:

ASW 14-10 (without battery and angled head) (14.4V)
71124209950

7 112 50 - ASW 14-6 PC
7 112 51 - ASW 14-10 PC
7 112 52 - ASW 14-14 PC
7 112 40 - ASW 14-6
7 112 42 - ASW 14-10
7 112 58 - ASW 14-14

