

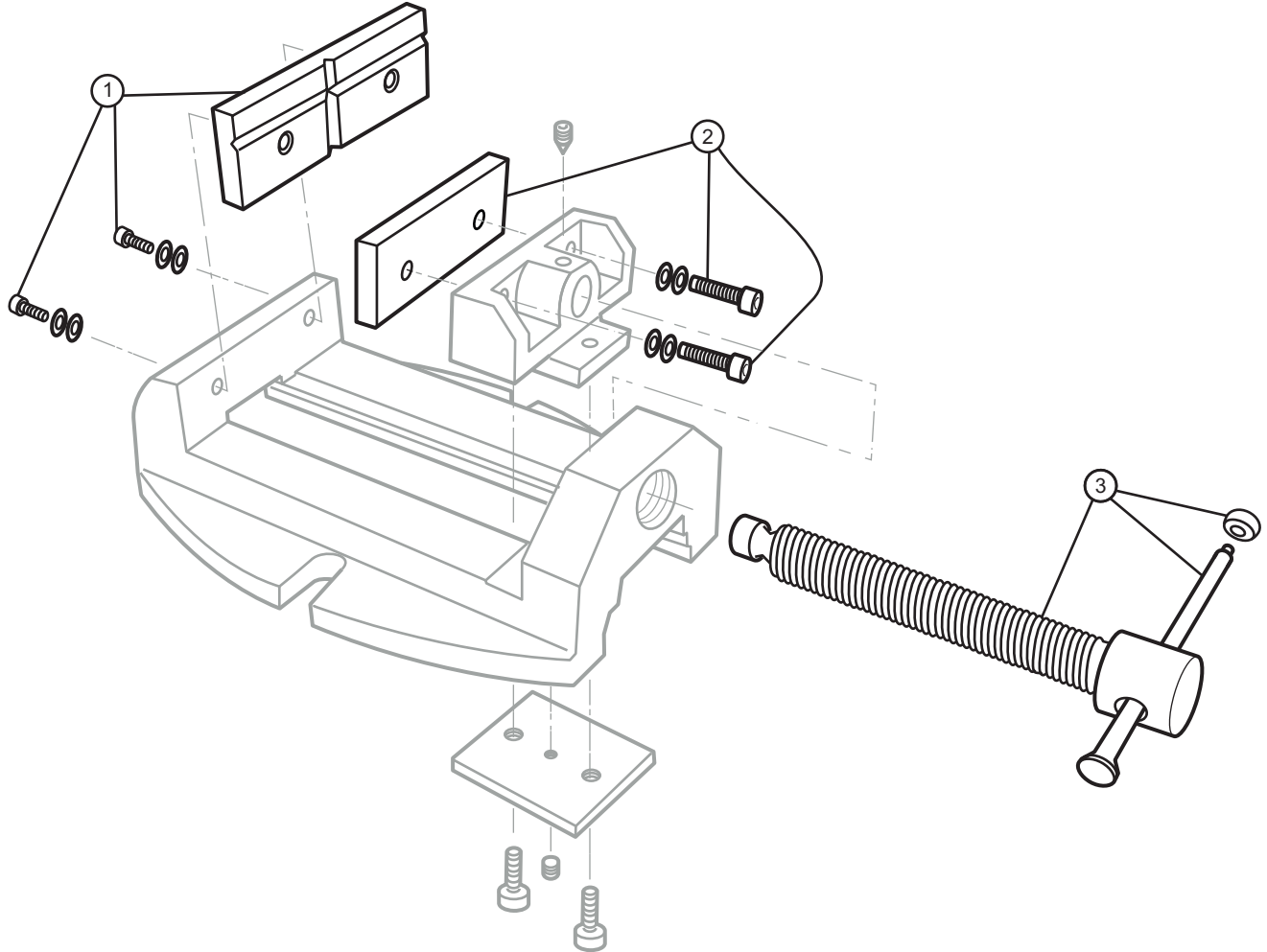

**Versatile Drill Press - Continuous Nut Parts Diagram**

5" Jaw Width, 5-7/8" Jaw Opening, 1-7/8" Jaw Depth

Stock #: 63240 Model #: 1360



#	Part	Description
1	63240-01	Fixed Jaw Insert
2	63240-02	Movable Jaw Insert
3	63240-03	Clamp Screw