

Circular hand saw - F 012 578 000 - 5780

Item	Part Number	Description	Illustration	Price	Quantity	Price Group
4	1 619 X05 812	Mains switch	1	-,-	1	-
5	1 619 X04 541	Power supply cord	1	-,-	1	-
8	1 619 X02 024	Nameplate	1	-,-	1	-
19	1 619 X01 012	Screw	1	-,-	2	10
20	1 619 X00 718	Warning Plate	1	-,-	1	-
23	1 619 X01 011	Screw	1	-,-	7	10
26	1 619 X00 657	Bearing Plate	1	-,-	1	20
27	1 619 X01 786	Contact Screw	1	-,-	4	10
28	1 619 X00 659	Washer	1	-,-	1	-
29	1 619 X00 660	Washer	1	-,-	1	11
30	1 619 X00 742	Housing Cover	1	-,-	1	-
33	1 619 X03 951	Pivoting Blade Guard	1	-,-	1	24
34	1 619 X04 824	Extension Spring	1	-,-	1	10
35	1 619 X04 655	Lever	1	-,-	1	11
36	1 619 X00 667	Retaining snap ring	1	-,-	1	14
37	1 619 X02 073	Set Of Handles	1	-,-	1	-
40	1 619 X02 074	Base Plate	1	-,-	1	-
41	2 610 917 567	Knob	1	-,-	1	20
42	1 619 X00 674	Bolt	1	-,-	1	10
43	1 619 X00 676	Roller Pin	1	-,-	1	11
45	1 619 X02 045	Depth-Gauge	1	-,-	1	10
46	2 610 923 854	Clip	1	-,-	1	10
47	1 619 X01 014	Spring Washer	1	-,-	1	10
48	1 619 X00 681	Stopper	1	-,-	1	11
49	1 619 X00 682	Spacer	1	-,-	1	10
50	1 619 X00 683	Screw	1	-,-	1	11
51	1 619 X00 935	Hex Screw	1	-,-	1	10
60	1 619 X01 409	Holding Pin	1	-,-	2	10
70	1 619 X02 076	Insulating Housing	1	-,-	1	-
73	1 619 X00 767	Cover	1	-,-	1	-
75	1 619 X01 836	Cap	1	-,-	1	-
76	1 619 X02 075	Auxiliary Handle	1	-,-	1	-
79	1 619 X01 835	Lens	1	-,-	1	-

Item	Part Number	Description	Illustration	Price	Quantity	Price Group
81	1 619 X02 081	Guide Piece	1	-,-	1	-
86	1 619 X02 271	Cyl Head tapping screw	1	-,-	1	-
87	1 619 X02 011	Cyl Head tapping screw	1	-,-	1	-
88	1 619 X02 044	Nut	1	-,-	1	-
89	1 619 X03 272	Warning Plate	1	-,-	1	-
91	1 619 X02 273	Compression Spring	1	-,-	1	-
92	1 619 X02 029	Laser module	1	-,-	1	-
93	2 610 918 224	Compression Spring	1	-,-	1	-
94	1 619 X02 014	Warning Plate	1	-,-	1	-
96	1 619 X02 030	Screw	1	-,-	1	-
97	1 619 X03 440	Washer	1	-,-	1	-
98	1 619 X03 422	Cyl Head tapping screw	1	-,-	1	-
651	1 619 X02 046	Box Wrench	1	-,-	1	-
822	1 619 X02 851	Carbon-Brush Set	1	-,-	1	19

Illustration - Type E

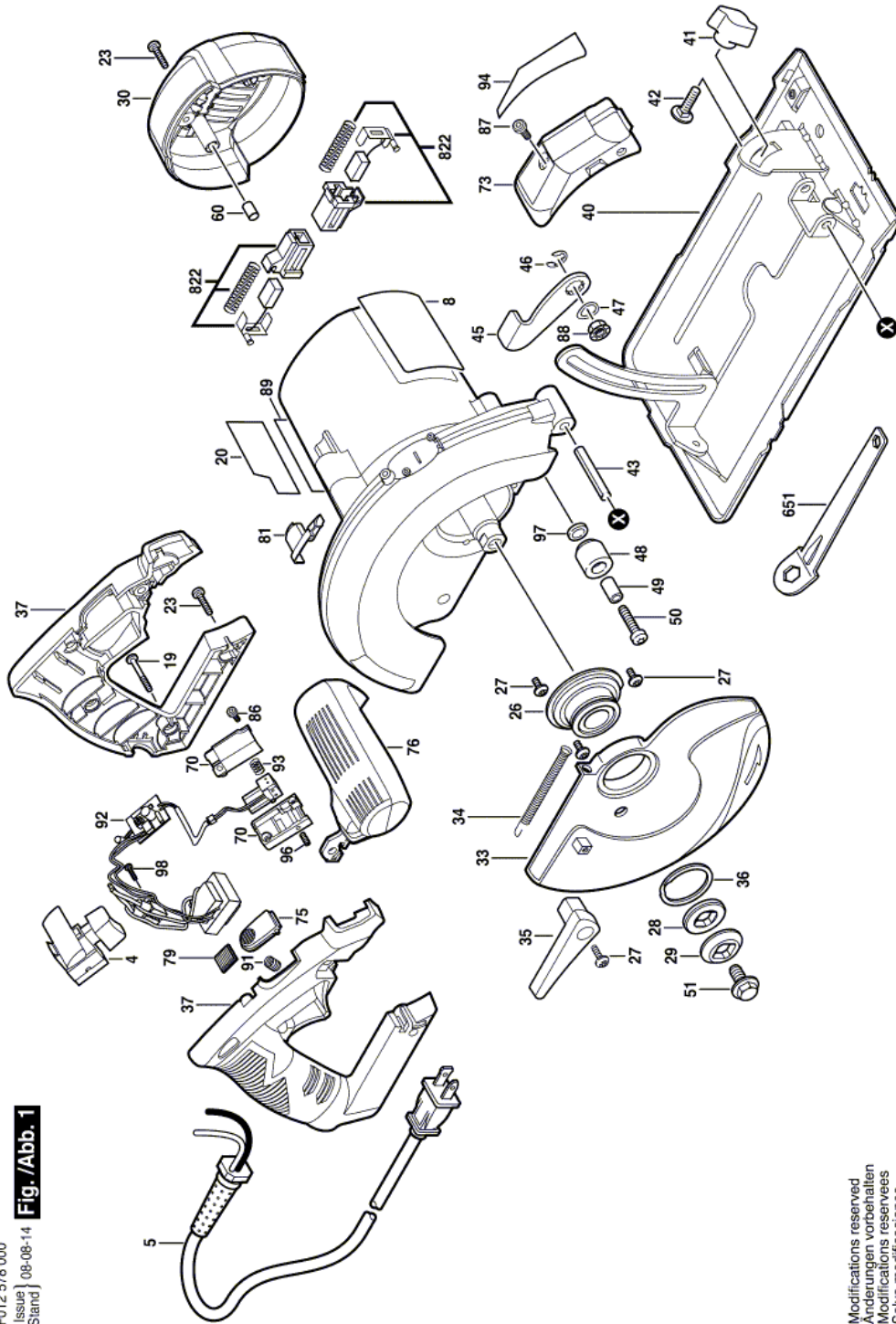

F012 578 000
Issue] 08-08-14
Stand] **Fig. /Abb. 1**

Modifications reserved
Änderungen vorbehalten
Modificacions reserveses
Salvo modificaciones

Information subject to change without further notice.