

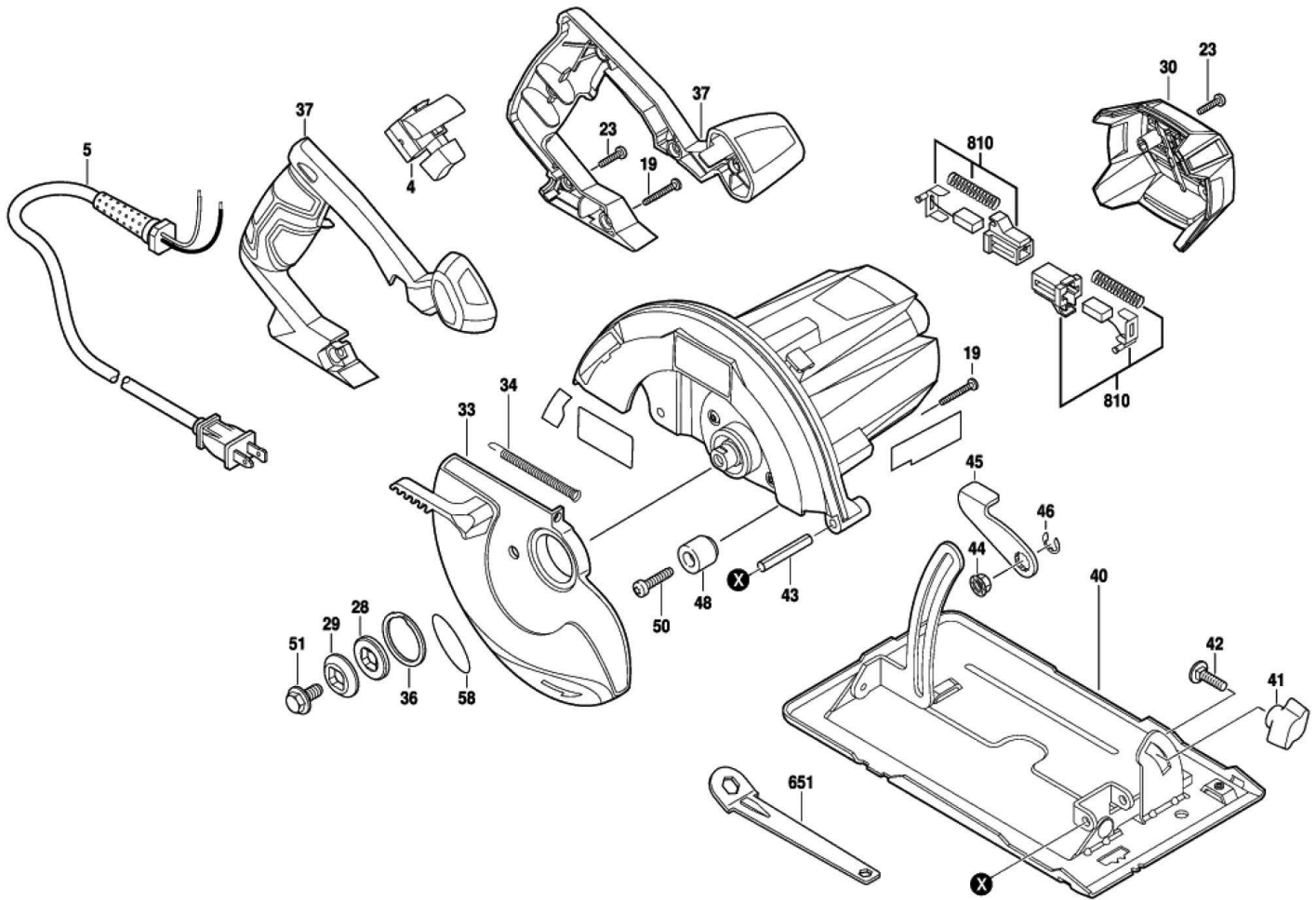

Product Description: Circular Saw
Model Number: 5080-01
Body Number: 0610212001
Version: A
Issue Date: 2020/05/27



No.	Product Model#	Part Number	Description	Qty
4	5080-01	4870620001	Trigger Switch	1
5	5080-01	2825544002	Power Cord ASSY	1
19	5080-01	5620621001	Thread Forming Screw	3
23	5080-01	5620599001	Hexagon Socket Screw	6
28	5080-01	3521011001	Inner Flange	1
29	5080-01	3521010001	Outer Flange	1
30	5080-01	3129119001	Rear Cover	1
33	5080-01	3129120001	Lower Guard	1
34	5080-01	3660667002	Tension Spring	1
36	5080-01	5660250001	Circlip For Shaft	1
37	5080-01	3900097001	Handle Set	1
40	5080-01	2825479003	Base Plate Set	1
41	5080-01	5630318001	Wing Nut	1
42	5080-01	5640259001	Square Neck Bolt	1
43	5080-01	5670462001	Spring Pin	1
44	5080-01	5630314001	Nut	1
45	5080-01	3706400001	Lever	1
46	5080-01	5660256001	E Ring	1
48	5080-01	3129128001	Stopper	1
50	5080-01	5620624001	Tapping Screw	1
51	5080-01	5620585001	Flange Bolt	1
58	5080-01	2241159002	Label	1
651	5080-01	5680226001	Hexagon Wrench	1
810	5080-01	4960365001	Carbon Brush Set	1