

# PARTS LEGEND

# Positive Placement®

F250S-PP, 500855

▲ 1	501043	1	T.H.S.C.S. 1/4 -20 x 1/2"	42	071297	3	Roll Pin 1/8 x 1-1/8"
2	501752	1	Air Deflector	*43	092174	1	O-Ring, Valve Body
3	501300	4	S.H.C.S. 1/4-20 x 1-1/4"	44	401958	1	Valve Body
4	501017	1	Cap	45	501039	1	Sequential Trigger Assembly
*5	500461	1	O-Ring	→ 46	502480	1	Nose
*6	092042	2	O-Ring	47	095417	4	Lockwasher 5/16
7	500407	1	Spring, Main Valve	▲48	009016	4	S.H.C.S. 5/16-18 x 1"
*8	501001	1	Gasket, Cap	49	501006	1	Spring, W.C.E.
9	406041	1	Retaining Ring	50	500849	1	Upper W.C.E.
10	500455	1	Upper Valve Piston	51	404800	1	Washer, W.C.E.
11	401946	1	Seal, Main Valve	52	500850	1	Lower W.C.E.
*12	091208	1	O-Ring	*53	501409	1	Probe Pin
*13	401950	1	O-Ring	54	500717	1	Nail Cover
14	500456	1	Lower Valve Piston	55	500902	1	Follower
15	500454	1	Post	56	500783	1	3/16 Hex Key, Short Arm
*16	095432	1	O-Ring	57	501770	1	End Cap, Magazine-LF
17	500453	1	Bumper, Post	58	501771	1	End Cap, Magazine-RT
18	402906	1	B.H.S.C.S.10-32 x 5/8"	59	500848	1	Latch
*19	092971	1	O-Ring, Piston	60	501046	1	Drum Pin Assembly
20	500899	1	Piston	61	500513	1	Negator Assembly
■ *21	501061	1	Driver Blade	62	501500	1	Spring, Lever
22	402011	1	Seal Sleeve	▲63	501567	2	Screw 1/4-28 x 3/4"
23	501283	1	Sleeve, Machined	64	500509	1	Front Bracket
24	500249	1	O- Ring	65	501028	1	Spring, Latch
*25	092235	1	O-Ring, Sleeve	66	501360	1	Shoulder Screw #8
26	500779	1	Flange	67	066840	1	S.H.C.S. 8-32 x 3/4"
*27	501002	1	O-Ring	68	404414	2	Flatwasher #8
*28	500866	1	Bumper	69	404325	3	Stop Nut
29	501333	1	Label, Housing-Left	70	500520	2	Wear Strip
30	501334	1	Label, Housing -Right	** 71	500458	1	Warning Label
31	501286	1	Housing	72	501137	1	Logo Label
→32	501219	1	End Plug, Housing	→73	502563	1	5/16-24x7/8" B.H.C.S.
33	501299	2	S.H.C.S. 1/4-20x 1"	74	091618	1	S.H.C.S. 1/4-20 x 1/2"
34	091622	1	Reducing Pipe Bushing	75	501654	1	Magazine w/ Wear Strips
35	501410	1	O-Ring	→76	500525	1	5/16"-24, Lock Nut
36	402669	1	Pin, Trigger	→77	404274	1	Washer
37	501590	1	Lever	78	501336	1	Shoulder Screw
*38	501241	1	Probe	79	501136	1	Nameplate
39	402668	1	Retaining Washer	80	501480	1	Fastener Usage Label
40	097748	1	Spring, Valve Pin				
41	097746	1	Valve Pin				

- \* Denotes Normal Wear Items
- \*\* Make sure Warning Label (Part No. 500458) is properly affixed. Replace if necessary. Label available at no charge through the Service Department.
- ▲ Apply Loctite 242 (Blue) Part No. 093500
- Apply Loctite Green Part No. 401491
- Denotes New Change

### ▲ WARNING

All parts must be periodically inspected and replaced if worn or broken. Failure to do this can affect the tool's operation and present a safety hazard.

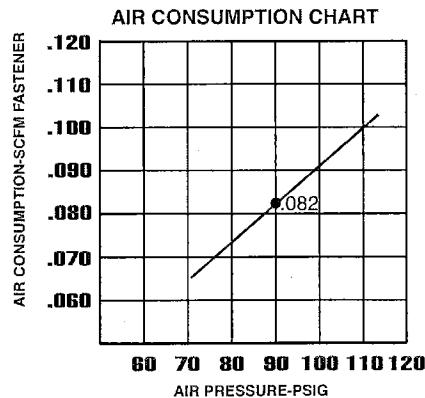

Note: For optimum performance Paslode recommends the use of a 3/8" Male fitting.

# Positive Placement®

F250S-PP

500855

## Piston Assembly 501468

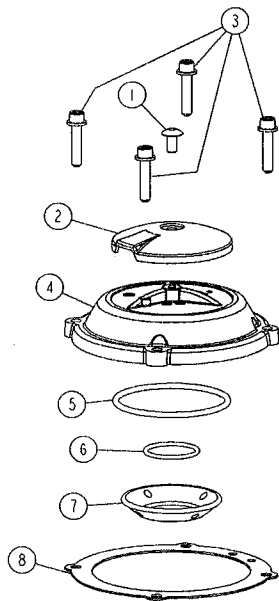
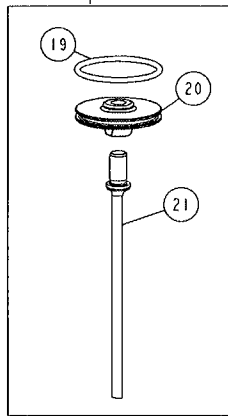

## Main Valve Assembly 500463

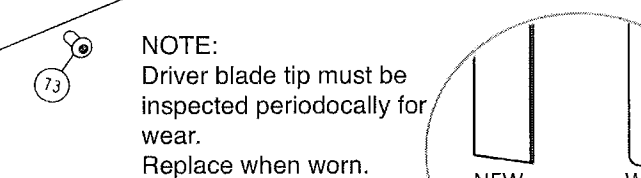
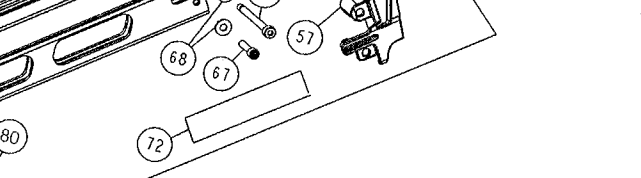
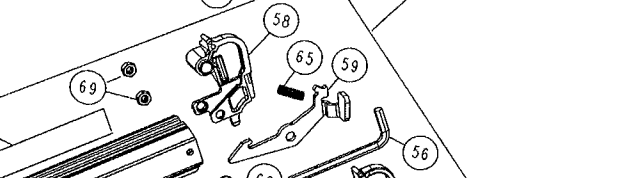
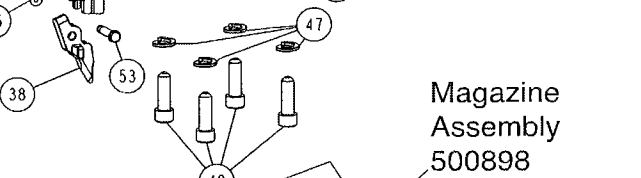
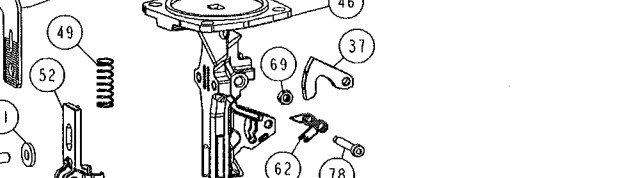
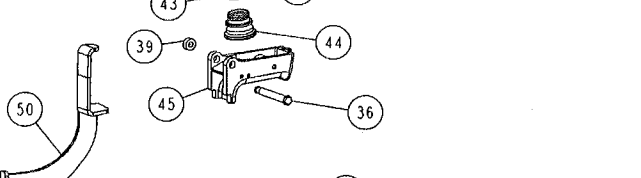
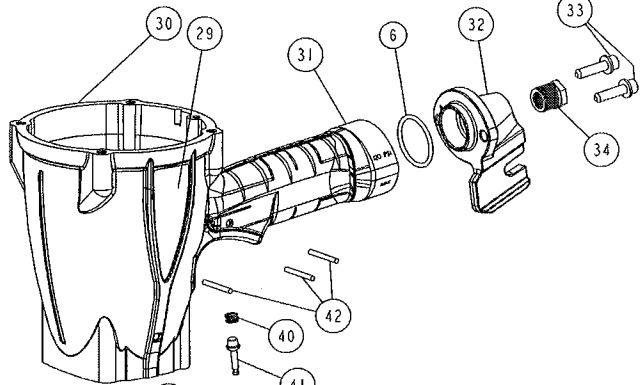
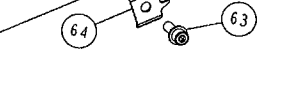
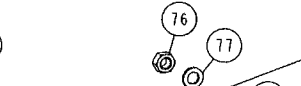
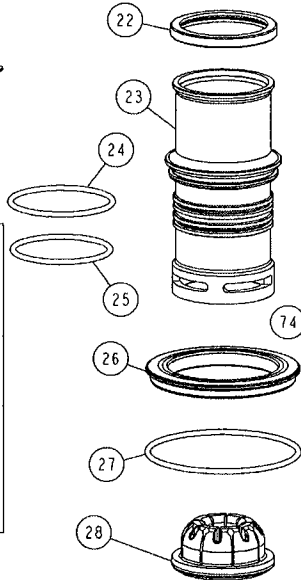
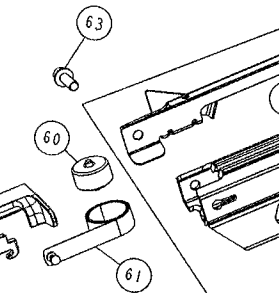
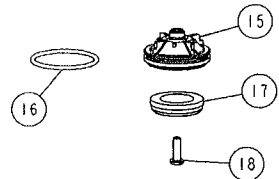
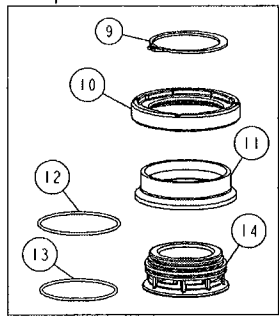

## Magazine Assembly 500898

NOTE:  
Driver blade tip must be  
inspected periodically for  
wear.  
Replace when worn.

