

3 601 H61 T10

Stand 10-95
Issue 10-02-03

Fig./Abb. 1

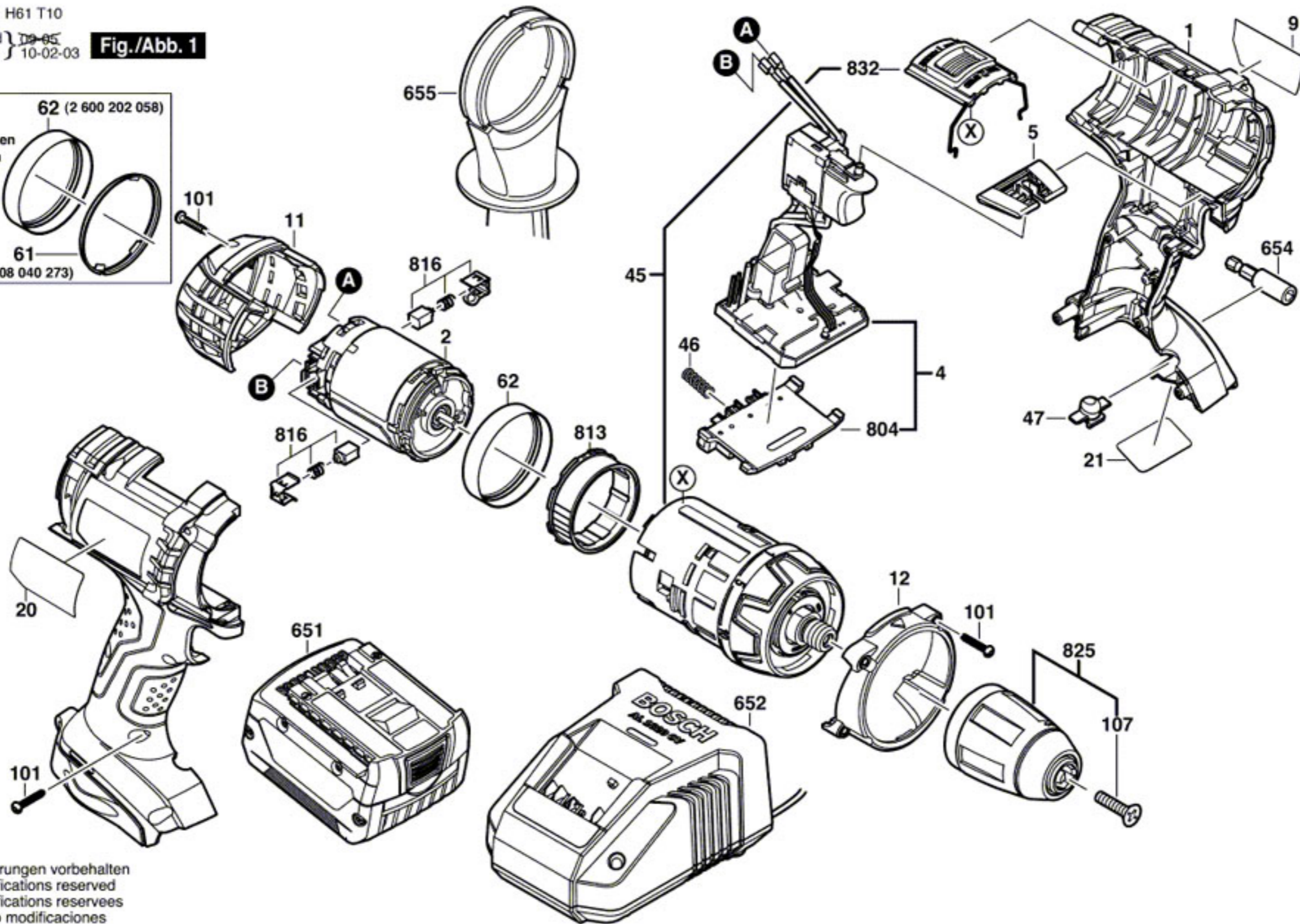

Änderungen vorbehalten
Modifications reserved
Modifications reserves
Salvo modificaciones