

* To maintain the required fit, the plunger housings are honed and fitted with the plunger and supplied as an assembly.

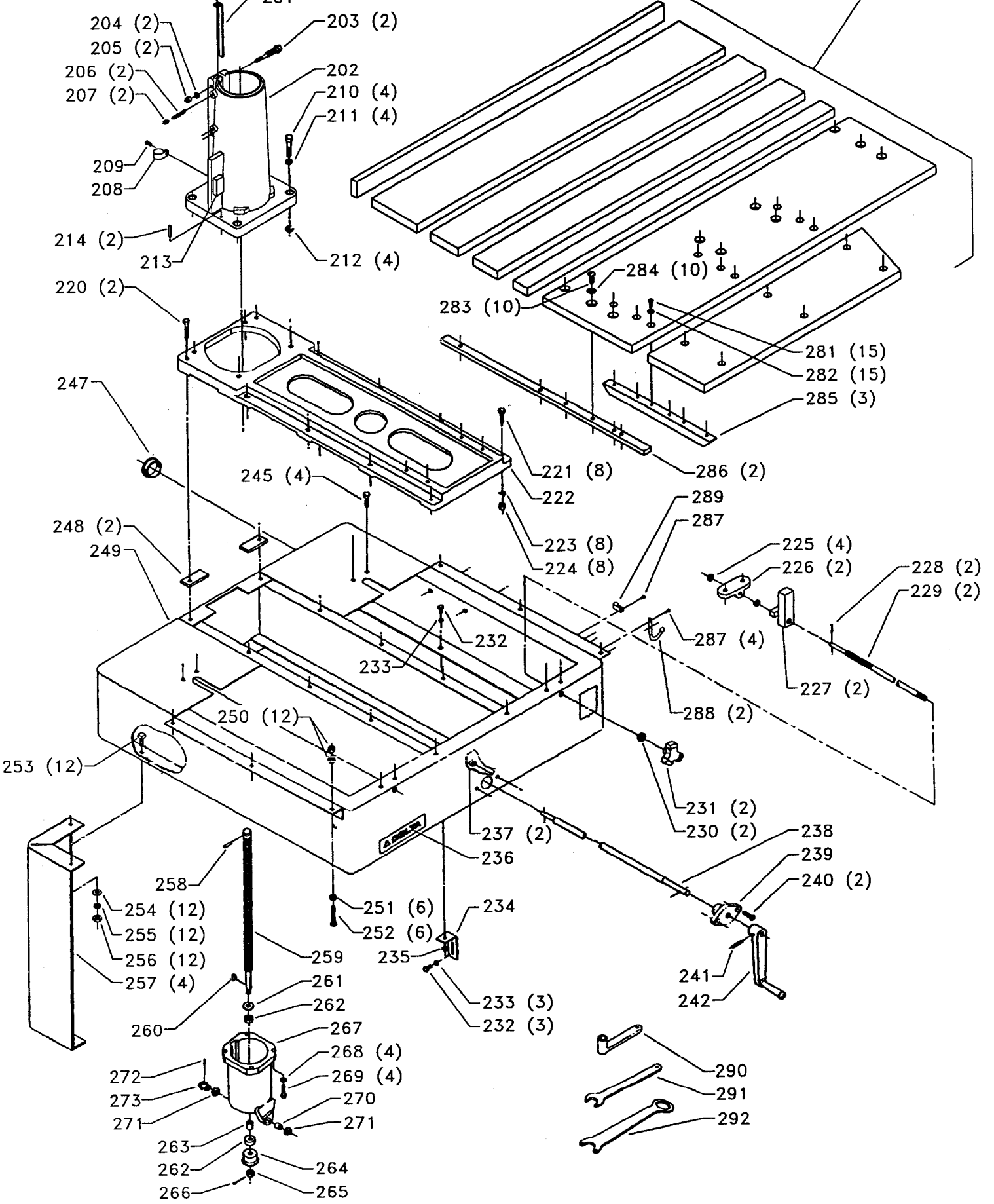

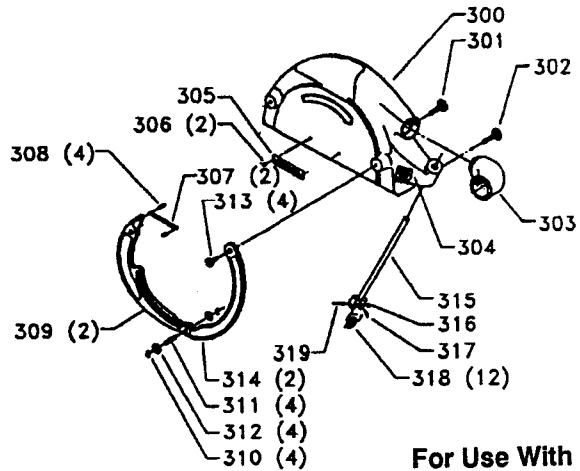

**For Use With
14" Radial Saws Only**

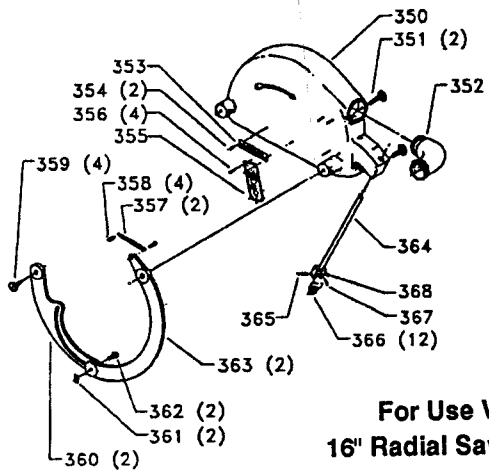

**For Use With
16" Radial Saws Only**

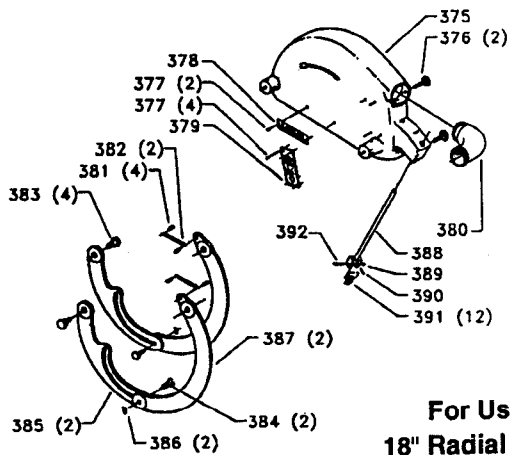

**For Use With
18" Radial Saws Only**

Parts List for 33-422 Type 1

Item Number	Part Number	Description	Qty Required
1	424030740002	HOLE PLUG	1
2	424030300009S	INDEX COLUMN	3
3	901010600605	CAP SCREW	3
4	904100313810	STEEL WASHER	3
5	424030740001S	LOCATING PIN	3
6	951020113974S	MITER SCALE	1
7	901064502250S	DRIVE SCREW	3
8	424030890016S	ARM	1
9	438010110051	BUSHING INSULATOR	1
10	000000-00	No Longer Available	1
11	901030408015S	CAP SCREW	1
12	905020107105	GROOVE PIN	2
13	901030308013S	SCREW	4
14	424040040005S	COLUMN KEY	1
15	904020201705	LOCK WASHER	4
16	901010603117	CAP SCREW	4
17	000000-00	No Longer Available	1
18	929760106318	ELEVATING NUT	1
19	904020101703S	LOCK WASHER	3
20	901010600649S	CAP SCREW	3
21	931010114091	BALL HANDLE	1
22	1085978S	HANDLE ASSY	1
23	1085979	LOCK SCREW	1
24	901041500206	SET SCREW	1
25	424030170003	SPACER	1
26	901030103345S	CAP SCREW	1
27	424040610003	CABLE SUPPORT	1

Parts List for 33-422 Type 1

Item Number	Part Number	Description	Qty Required
28	904010101610S	STEEL WASHER	1
29	951010107802S	POINTER	1
30	901020100558	MACHINE SCREW	1
31	901041701104	SET SCREW	1
32	424033880006	PLUNGER ASSY	1
33	928010415310S	SPRING	1
34	901064508210S	DRIVE SCREW	1
35	902010101300S	HEX NUT	1
36	931010214099S	KNOB-SCREW ON	1
37	905010106731S	ROLL PIN	1
38	1087358	CLAMP ASSY	1
39	406031380005S	KNOB	1
40	424030160002S	BUMPER	2
41	424031320007	RIP SCALE	1
42	901020100558	MACHINE SCREW	3
43	424033550012	TRACK ARM ASSY	1
44	901030100775S	CAP SCREW	4
45	000000-00	No Longer Available	2
46	905020107105	GROOVE PIN	2
47	904020201705	LOCK WASHER	4
48	901030103308	CAP SCREW	4
49	424007520002	WARNING LABEL	1
50	424031080007	ROD	4
51	902030202982	SPEED NUT	16
52	90513860	SCREW	16
60	906348	NUT	1
61	1085980S	YOKE PIN	1

Parts List for 33-422 Type 1

Item Number	Part Number	Description	Qty Required
62	424041110006S	ECCENTRIC STUD	2
63	424041110005S	STATIONARY STUD	2
64	920101514919	SPECIAL BEARING	4
65	901020100558	MACHINE SCREW	2
66	951010213951S	POINTER	1
67	424043270002	RIP LOCK ASSY	1
68	406031380005S	KNOB	1
69	424030720004S	HOLD DOWN STRIP	1
70	424033880007S	LOCATING HOUSING	1
71	931010214099S	KNOB-SCREW ON	1
72	928010415310S	SPRING	1
73	901030100784	CAP SCREW	2
74	904020201704S	LOCK WASHER	2
75	424030570002	ROLLER HEAD	1
76	901041500202	SET SCREW	2
77	424030160002S	BUMPER	2
78	904020201705	LOCK WASHER	4
79	902010201227S	HEX JAM NUT	4
87	424030160003	BUMPER	1
88	904010101604S	STEEL WASHER	1
89	901020100558	MACHINE SCREW	2
90	424040310018S	COVER	1
91	000000-00	No Longer Available	1
92	904020201705	LOCK WASHER	1
93	424040950002S	TRUNNION BOSS	1
94	904020101703S	LOCK WASHER	1
95	901030100750	CAP SCREW	1

Parts List for 33-422 Type 1

Item Number	Part Number	Description	Qty Required
96	901041601103	SET SCREW	1
97	424031020008S	YOKE	1
98	931010114091	BALL HANDLE	1
99	1085982S	HANDLE ASSY	1
100	A21680S	WARNING LABEL	1
101	902010401026S	HEX NUT	1
102	904010312925	SPEC WASHER	1
103	424040270004S	LOCK NUT	1
104	901072613234S	LOCK ROD	1
105	931010214099S	KNOB-SCREW ON	1
106	901010603121	CAP SCREW	1
107	901020100558	MACHINE SCREW	1
108	951010107802S	POINTER	1
109	904010101610S	STEEL WASHER	1
110	901020100567S	MACHINE SCREW	2
111	424031320010S	BEVEL SCALE	1
112	424033880007S	LOCATING HOUSING	1
113	928010415310S	SPRING	1
114	931010214099S	KNOB-SCREW ON	1
115	904020201704S	LOCK WASHER	2
116	901030100784	CAP SCREW	2
120	902010101282S	HEX JAM NUT	1
121	904010101618S	STEEL WASHER	1
122	424040540023	GUARD CLAMP	1
123	424041110010S	STUD	1
124	000000-00	No Longer Available	1
125	400061310017S	MTR 3PH 7.5HP RA18	1

Parts List for 33-422 Type 1

Item Number	Part Number	Description	Qty Required
125	400061310016S	MTR 1PH 5HP RA18	1
126	424040950001	TRUNNION BOSS	1
127	904020201705	LOCK WASHER	3
128	901030103308	CAP SCREW	2
129	901030100765	CAP SCREW	1
130	424041030006	BLADE FLANGE	1
131	000000-00	No Longer Available	1
132	424043600001	ARBOR NUT ASSY	1
133	901030108072S	SET SCREW	1
134	955030100047S	HEX WRENCH	1
200	901030408015S	CAP SCREW	1
201	424040520001S	GIB	1
202	000000-00	No Longer Available	1
203	424041110002S	STUD	2
204	904020201704S	LOCK WASHER	2
205	902010401026S	HEX NUT	2
206	901041500297S	SET SCREW	2
207	902010101206	HEX NUT	2
208	438010040052	CORD CLAMP	1
209	901030103318S	SCREW	1
210	901010603117	CAP SCREW	4
211	904020201705	LOCK WASHER	4
212	424040830001	SHIM WASHER	4
213	424030160003	BUMPER	1
214	905020107105	GROOVE PIN	2
220	901010600646S	CAP SCREW	2
221	901010600648S	CAP SCREW	8

Parts List for 33-422 Type 1

Item Number	Part Number	Description	Qty Required
222	000000-00	No Longer Available	1
223	904020201704S	LOCK WASHER	8
224	902010401026S	HEX NUT	8
225	904010331451	WASHER	4
226	424030140024	FENCE BRACKET	2
227	424033270003S	FENCE CLAMP NUT	2
228	000000-00	No Longer Available	2
229	424041120015S	FENCE CLAMP SCREW	2
230	961030131452	GROMMET	2
231	406031380008S	KNOB	2
232	901010600611S	CAP SCREW	3
233	491957-00	LOCK WASHER	3
234	424020140025S	LVC MTG BRACKET	1
235	489026-00	HEX NUT	1
236	424027520086S	NAMEPLATE	1
237	902010401026S	HEX NUT	2
238	1086622S	ELEVATING SHAFT	1
239	424040170006	HUB	1
240	901020300417	MACHINE SCREW	2
241	905020105045	GROOVE PIN	1
242	424033330001S	ELEVATING CRANK	1
245	901010600640S	CAP SCREW	4
247	438010110020	INSULATOR	1
248	424040040008S	REINFORCING STRIP	2
249	000000-00	No Longer Available	1
250	902010401026S	HEX NUT	12
251	489191-00	HEX NUT	6

Parts List for 33-422 Type 1

Item Number	Part Number	Description	Qty Required
252	901040200324	3/8-16 X 2 SET SCREW	6
253	901010600642	CAP SCREW	12
254	904010101615	STEEL WASHER	12
255	904020201704S	LOCK WASHER	12
256	489191-00	HEX NUT	12
257	424040660004S	LEG	4
258	905010102730	ROLL PIN	1
259	424031120002S	ELEVATING SCREW	1
260	927010102607	KEY	1
261	904010301649S	STEEL WASHER	1
262	920520113924	BEARING	2
263	920240613962	BEARING	1
264	424023510001	GEAR ASSY	1
265	902011501011	HEX NUT	1
266	905050402106S	COTTER PIN	1
267	424030130003	COLUMN HOUSING	1
268	904020201704S	LOCK WASHER	4
269	901010600648S	CAP SCREW	4
270	920240613962	BEARING	1
271	920760213909	THRUST BEARING	2
272	905020105030	GROOVE PIN	1
273	424023510001	GEAR ASSY	1
280	424043910006	TABLE BOARD SET	1
281	901020100511	MACHINE SCREW	15
282	904010101614S	STEEL WASHER	15
283	901020107502	MACHINE SCREW	10
284	904010101615	STEEL WASHER	10

Parts List for 33-422 Type 1

Item Number	Part Number	Description	Qty Required
285	424030040014S	EXTENSION BAR	3
286	424040040004S	CLAMP STRIP	2
287	901052131498	SCREW	4
288	422350600001S	WRENCH HOOK	2
290	424031170001	SOCKET WRENCH	1
291	955010301488S	OPENEND ARBOR WRENCH	1
292	955021001492S	COMBINATION WRENCH	1
375	424043540017	18 BLADE GUARD ASSY	1
376	901042601528S	THUMB SCREW	2
377	901064502250S	DRIVE SCREW	6
378	000000-00	No Longer Available	1
379	424027520084S	CAUTION PLATE	1
380	424040360001S	DUST SPOUT	1
381	424041110009S	STUD	4
382	928022313394S	SPRING	2
383	424041110007S	STUD	4
384	424041110008S	BEARING STUD	2
385	424040540018S	FRONT LEAF	2
386	904152107403S	CLIP	2
387	424040540017S	REAR LEAF	2
388	1086605	ANTI-KICK ASSY	1
389	904150620269S	SNAP RING	1
390	905020102489S	GROOVE PIN	1
391	424040470002S	ANTI-KICK FINGER	12
392	424040710013S	PIN	1