

0 603 269 139

Issue } 00-07-14  
Stand }

**Fig./Abb. 1**

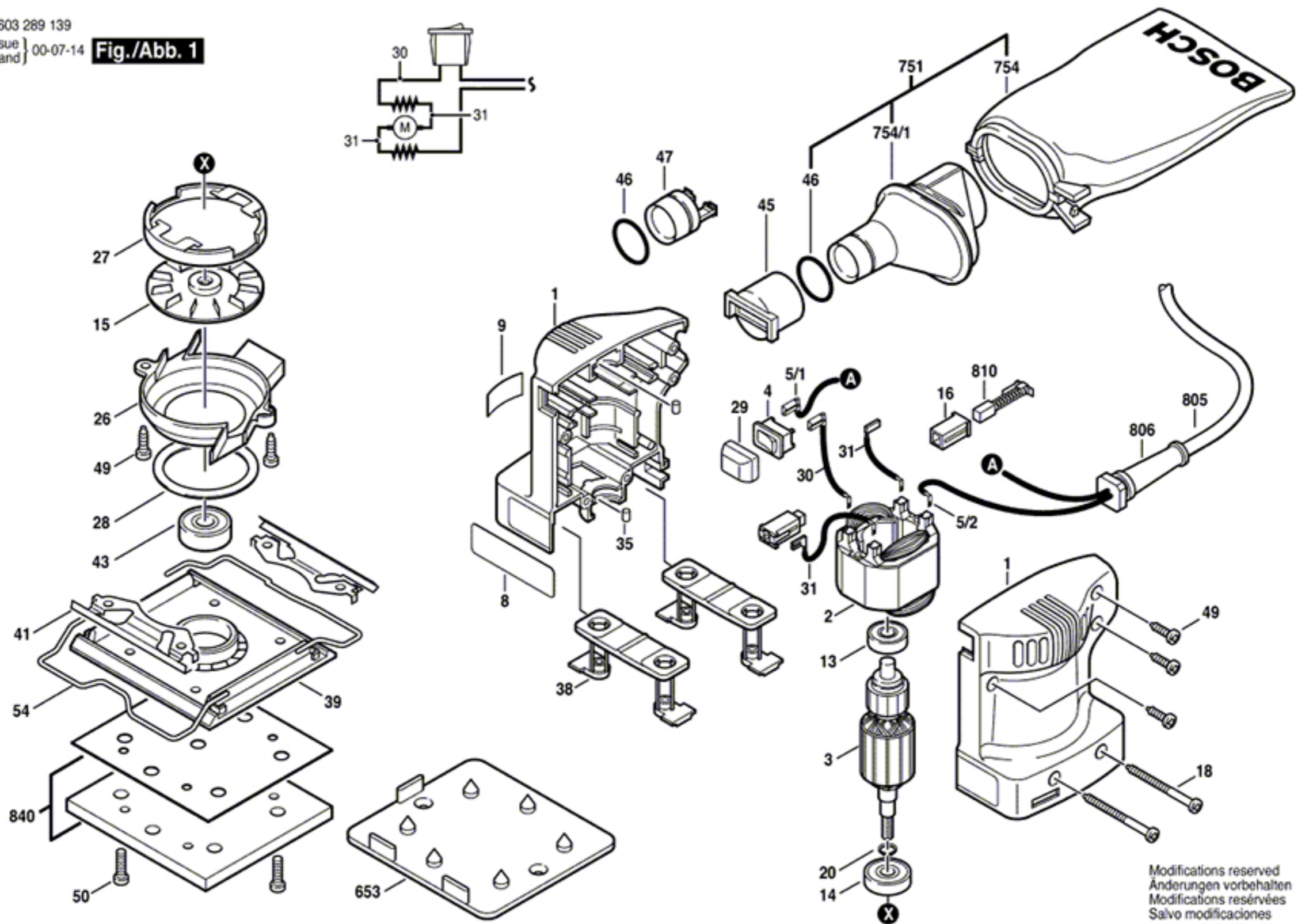

Modifications reserved  
Änderungen vorbehalten  
Modifications réservées  
Salvo modificaciones