

**FOR USE WITH MODEL 28-293 & 28-299**

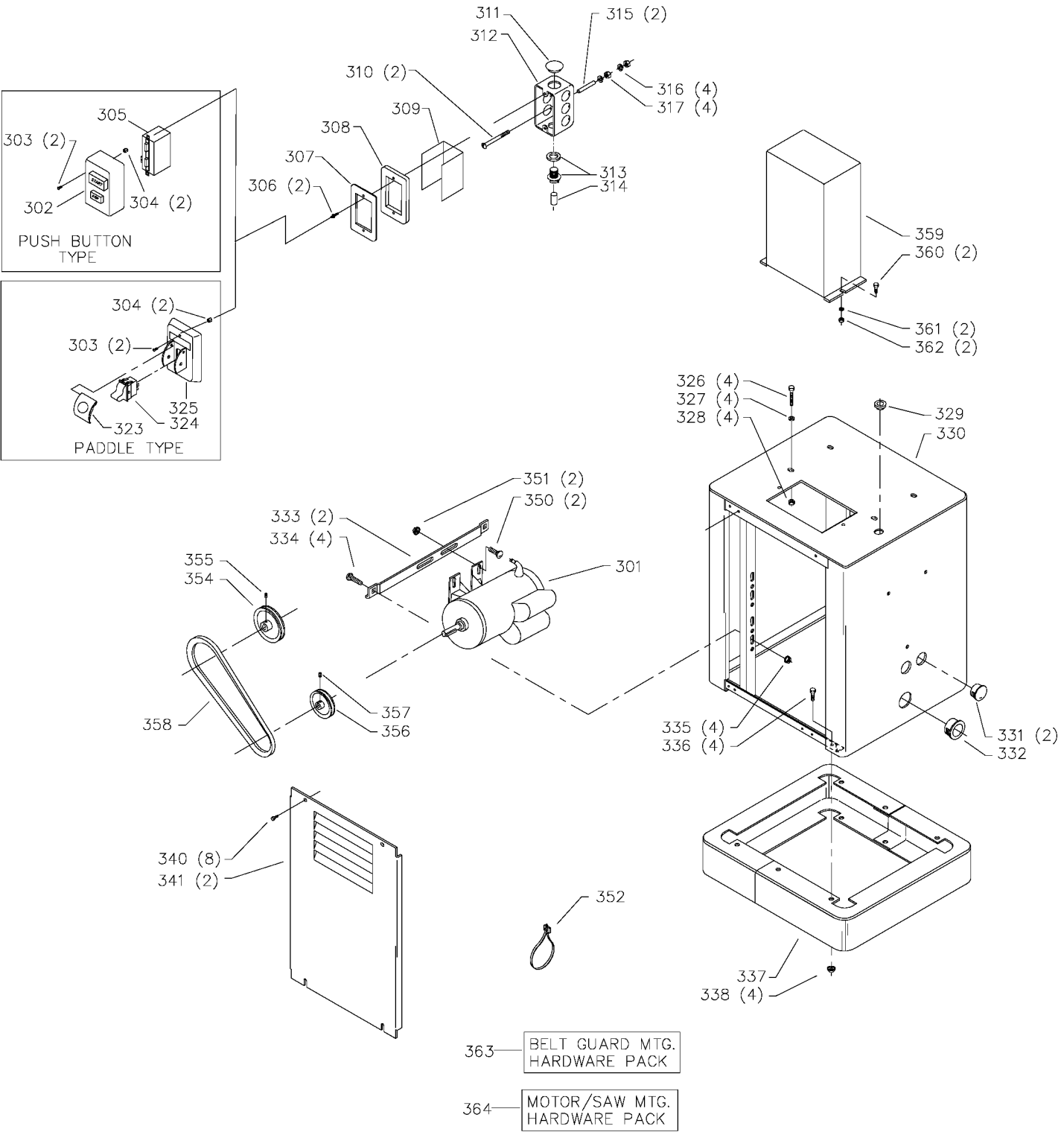

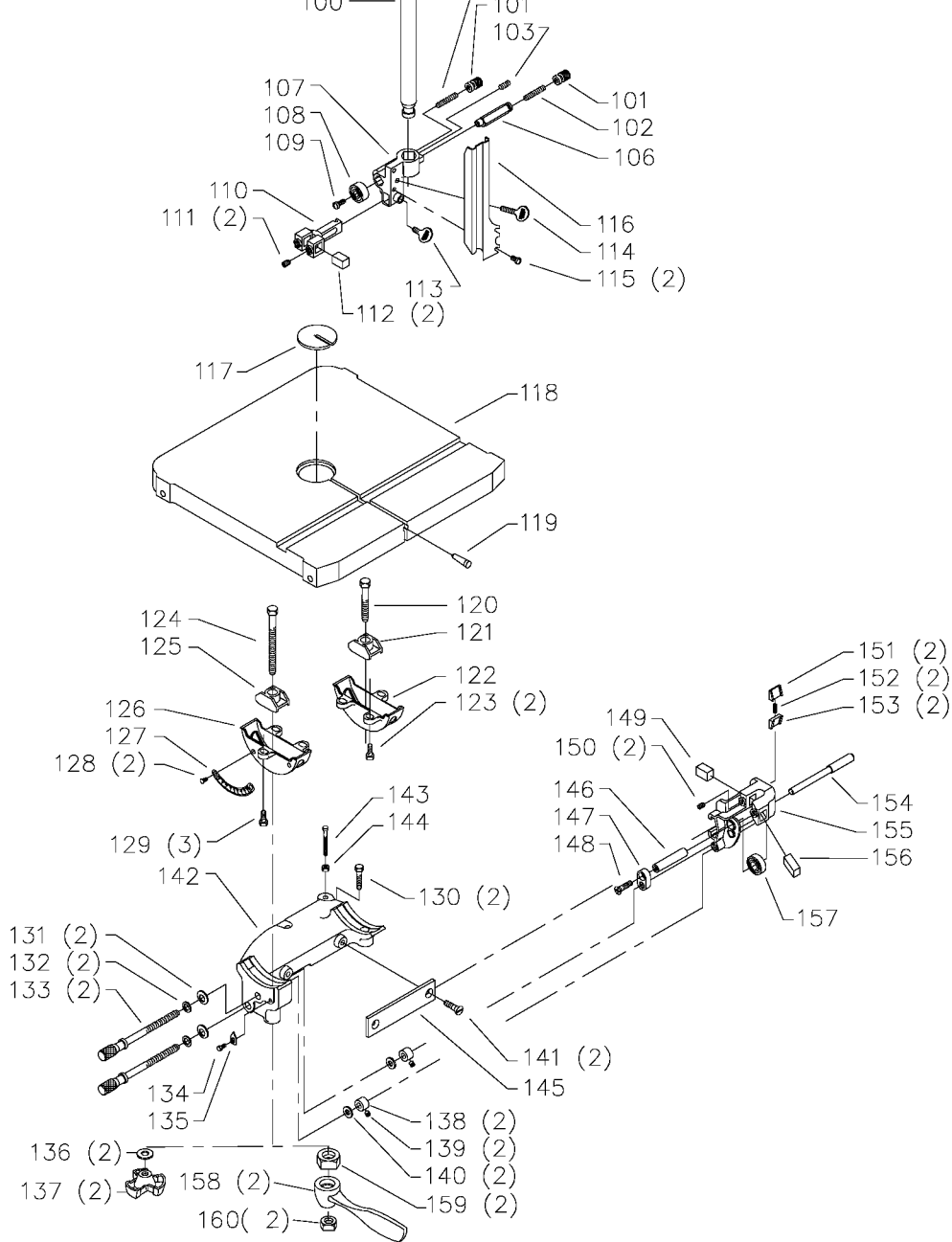

**USE WITH MODELS 28-231 & 28-278**

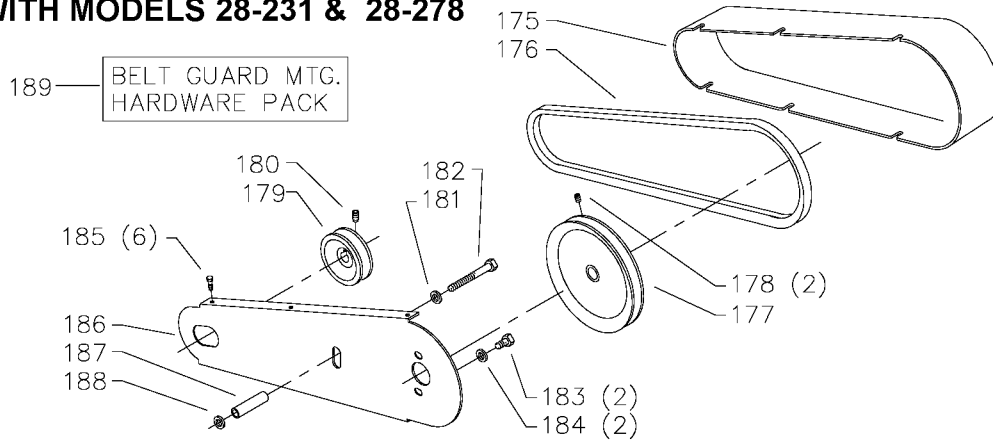

## Parts List for 28-299 Type 1

Item Number	Part Number	Description	Qty Required
1	426023540049S	GUARD	1
2	406030600002	KNOB	1
3	426020710002	DOOR LOCK STUD	1
4	902012931513S	KEPS NUT	1
5	902010201227S	HEX JAM NUT	1
6	426034000008	UPPER WHEEL ASSY	1
7	426020940003S	TIRE	1
8	920040107273	BEARING	2
10	426021040006S	SPACER	1
11	901020121910	RD HD SCREW	1
12	904010101615	STEEL WASHER	1
13	426020540017	BLADE GUARD	1
14	901027631527	CAP SCREW	1
15	904010101615	STEEL WASHER	1
16	426023890004	UPPER FRAME ASSY	1
17	426021110006	STUD	1
18	426023540048	GUARD	1
19	902011331529S	1/4-20 FLANGED NUT	3
20	901027631527	CAP SCREW	2
21	904010101620S	WASHER	1
22	426021110001	HEX STUD	1
23	426021220003	DOOR CATCH	1
24	901020512860	SCREW	1
25	904010322477	SPECIAL WASHER	1
26	426021060004	UPPER WHEEL SHAFT	1
27	426020590001	HINGE	1
28	905155	KNOB	1

## Parts List for 28-299 Type 1

Item Number	Part Number	Description	Qty Required
29	000000-00	No Longer Available	1
29	426020140003	SLIDING BRACKET	1
30	905041413146	STEEL PIN	1
31	902040101403	WING NUT	1
32	901042614005	SCREW	1
33	928010413386	COIL SPRING	1
34	904070105572	FIBRE WASHER	1
35	902020501317	SPEC NUT	1
36	426023270003	GUIDE LOCK KNOB	1
37	901010609062	BOLT	1
38	904010101611	STEEL WASHER	1
39	904020201707	LOCK WASHER	1
40	902011001027	HEX NUT	1
41	000000-00	No Longer Available	1
42	438010040082	5/8 DIA CLAMP	1
43	901030103318S	SCREW	1
44	905040714460	DOWEL PIN	2
45	902070307171S	SPEC NUT	1
46	904010314982	WASHER	1
47	920040205348	BEARING	1
48	928070107353	BEARING LOAD SPRING	1
49	426021220004	SPRING CLIP	1
50	491957-00	LOCK WASHER	1
51	901030100763	CAP SCREW	1
52	436010162001S	BUMPER	1
53	426020260003	DUST SPOUT	1
54	901030631340	SHOULDER SCREW	1

## Parts List for 28-299 Type 1

Item Number	Part Number	Description	Qty Required
58	426021110001	HEX STUD	1
59	426021220003	DOOR CATCH	1
60	901020512860	SCREW	1
61	426021060010	LOWER DRIVE SHAFT	1
62	927030102650S	KEY	1
63	927011002603	HI-PRO KEY	1
64	920040205348	BEARING	1
65	904010314982	WASHER	1
66	426034000010	LOWER WHEEL	1
67	426020940003S	TIRE	1
68	902070307171S	SPEC NUT	1
69	000000-00	No Longer Available	1
69	000000-00	No Longer Available	1
70	901027631530	CAP SCREW	3
73	426020710002	DOOR LOCK STUD	1
74	902012931513S	KEPS NUT	1
75	406030600002	KNOB	1
85	49-220	HOSE ADAPTER	1
86	000000-00	No Longer Available	1
87	50-484	4IN TO 2-1/2IN PL AD	1
100	426020550001	GUIDE POST	1
101	902080413064S	NUT	2
102	901041500297S	SET SCREW	2
103	901041900207S	SET SCREW	1
106	426021060009S	HEXAGON SHAFT	1
107	426023550002S	UPPER BLADE GUIDE	1
107	426020890002S	BRACKET	1

## Parts List for 28-299 Type 1

Item Number	Part Number	Description	Qty Required
108	920080201457S	BEARING	1
109	901030408015S	CAP SCREW	1
110	426020140004S	BRACKET	1
110	426023550003	BRACKET ASSY	1
111	901041900225S	SET SCREW	2
112	952020113254S	GUIDE BLOCK	2
113	901042601520S	THUMB SCREW	1
114	901042601528S	THUMB SCREW	1
115	901030408015S	CAP SCREW	2
116	426020540001	BLADE GUARD	1
117	426020630001S	INSERT-24SS ONLY	1
118	000000-00	No Longer Available	1
119	426020710001S	PIN	1
120	000000-00	No Longer Available	1
121	426020270001	CLAMP SHOE	1
122	426020950002S	TRUNNION	1
123	901027631530	CAP SCREW	2
124	901010600637	CAP SCREW	1
125	426020270001	CLAMP SHOE	1
126	426023950005	TRUNNION ASSY	1
127	426021320001S	SCALE	1
128	903030231333S	RIVIT	2
129	901027631530	CAP SCREW	3
130	901010600602	CAP SCREW	2
131	928050131378	SPRING WASHER	2
132	904070105571S	FIBRE WASHER	2
133	426024120004	ADJ SCREW W/KNOB	2

## Parts List for 28-299 Type 1

Item Number	Part Number	Description	Qty Required
134	901030122144	SCREW	1
135	951010107802S	POINTER	1
136	904010312925	SPEC WASHER	2
137	000000-00	No Longer Available	2
138	426033880001	SET COLLAR ASSY	2
139	491950-00	SET SCREW	2
140	904070105571S	FIBRE WASHER	2
141	901020300408	MACHINE SCREW	2
142	426023140008	TRUNNIONSUPPORT ASSY	1
143	901010603125S	CAP SCREW	1
144	1087640S	LOCK NUT	1
145	426020040001S	STEEL RAIL	1
146	904101013166S	SPACER	1
147	426020140013S	ADJUSTING LINK	1
148	901030308013S	SCREW	1
149	952020113254S	GUIDE BLOCK	1
150	901041900225S	SET SCREW	2
151	426020980001S	WEDGE	2
152	928010213387S	COIL SPRING	2
153	426020980001S	WEDGE	2
154	426021060011S	SHAFT	1
155	426023550004S	LOWER BLADE GUIDE	1
155	426020140006S	SUPPORT BRACKET	1
156	952020113253S	ANGLE GUIDE BLOCK	1
157	920080201457S	BEARING	1
301	000000-00	No Longer Available	1
302	1340100	SWITCH COVER ASSY	1



## Parts List for 28-299 Type 1

Item Number	Part Number	Description	Qty Required
303	901020100567S	MACHINE SCREW	1
304	402071045007S	SPACER	1
305	905224	SWITCH	1
306	402071115002S	STUD	1
307	438010210149S	SWITCH PLATE	1
308	422041160001S	GASKET	1
309	438010110036	INSULATION	1
310	901021207533	MACHINE SCREW	1
311	438010110064	PLUG	1
312	438010010055	UTILITY BOX	1
313	438010040007S	CLAMP	1
314	438010110054S	INSULATOR SLEEVE	1
315	430021040005	1-3/4 SPACER	1
316	491957-00	LOCK WASHER	1
317	489026-00	HEX NUT	1
323	422390670001	SWITCH ACTUATOR	1
324	438010170206S	SWITCH	1
325	000000-00	No Longer Available	1
326	901010600613	MACHINE SCREW	1
327	491956-00	WASHER	1
328	902015031514	FLANGED HEX NUT	1
329	438010110051	BUSHING INSULATOR	1
330	000000-00	No Longer Available	1
331	438010110065	PLUG	1
332	438010110020	INSULATOR	1
333	436010040022S	MOTOR BRACKET	1
334	901110200834S	CARRIAGE BOLT	1

## Parts List for 28-299 Type 1

Item Number	Part Number	Description	Qty Required
335	902015031514	FLANGED HEX NUT	1
336	901010600607S	SCREW	1
337	436013050001S	SUB BASE	1
338	902015031514	FLANGED HEX NUT	1
340	901064431806S	SCREW	1
341	436011230008S	PANEL	1
350	901110200834S	CARRIAGE BOLT	1
351	902015031514	FLANGED HEX NUT	1
352	438010040054	CABLE TIE	1
354	926010431763	PULLEY	1
355	901041500231S	SET SCREW	1
356	926010419366	MOTOR PULLEY 2-1/4OD	1
357	901041500231S	SET SCREW	1
358	49-051	V BELT-REPLACES 501	1
359	000000-00	No Longer Available	1
360	901010600612S	CAP SCREW	1
361	904010101614S	STEEL WASHER	1
362	489026-00	HEX NUT	1
363	000000-00	No Longer Available	1
364	436017250002S	HARDWARE BAG	1
370	438013020315	POWER CORD	1
371	438010180041S	WIRE TERMINAL	1
372	438013020604	SWITCH CORD	1
373	438010180041S	WIRE TERMINAL	1
374	901064231170S	HEX HD SCREW	1