



SERVICE PARTS LIST

BULLETIN NO.
54-26-2590

SPECIFY CATALOG NO. AND SERIAL NO. WHEN ORDERING PARTS		REVISED BULLETIN	DATE
M12™ FUEL™ 1/2" Impact Wrench w/ Detent Pin			June 2018
CATALOG NO.	2555P-20	STARTING SERIAL NO.	J63A
		WIRING INSTRUCTION See Pages 2 & 3	

EXAMPLE:

00	0
----	---

 Component Parts (Small #)
 Are Included When Ordering
 The Assembly (Large #).

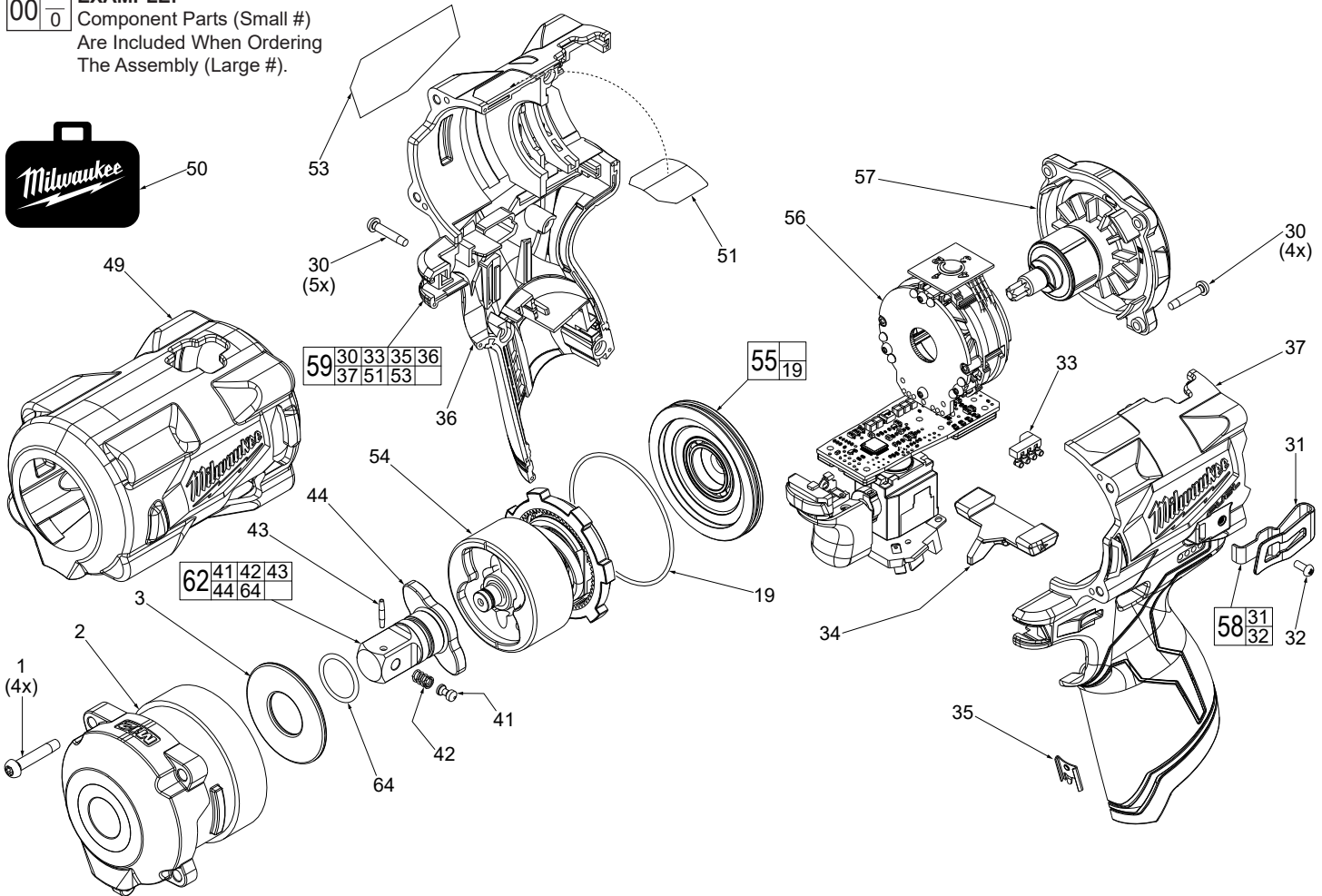
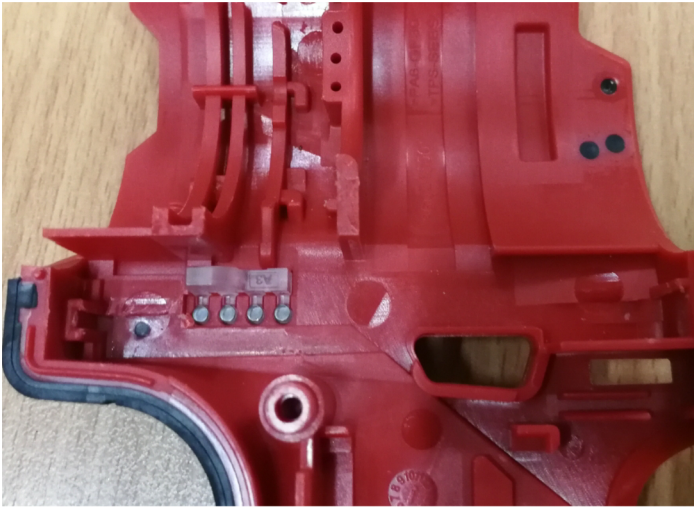

FIG.	PART NO.	DESCRIPTION OF PART	NO. REQ.
1	05-88-1255	M4 x 22mm Pan Hd. ST T-20 Screw	(4)
2	28-50-2555	1/2" Gear Case	(1)
3	45-88-2555	Front Gear Case Washer	(1)
19	34-40-2554	O-Ring	(1)
30	06-82-6351	M3 x 16mm Pan Hd. ST T-10 Screw	(9)
31	-----	Belt Clip	(1)
32	05-88-1015	M2.5 x 6mm Pan Hd. Phil. Mach. Scr.	(1)
33	23-28-0320	Light Pipe	(1)
34	45-24-2554	Forward/Reverse Shuttle	(1)
35	42-70-0058	Housing Clip	(1)
36	-----	Right Housing Halve - Cover	(1)
37	-----	Left Housing Halve - Support	(1)
41	44-60-0014	Detent Pin	(1)
42	40-50-0925	Detent Spring	(1)
43	44-60-0022	Solid Pin	(1)
44	-----	1/2" Anvil	(1)
49	49-16-2554	Rubber Boot (Optional, Accessory)	(1)
50	42-55-0300	Zippered Canvas Tool Bag	(1)
51	10-20-2553	Warning Label	(1)
53	12-20-2554	Service Nameplate	(1)
54	14-30-2554	Impacting Assembly	(1)
55	44-66-2554	End Cap Assembly	(1)
56	14-20-2554	Electronics Assembly	(1)
57	16-01-2554	Rotor/Back Cap Assembly	(1)
58	42-70-0495	Belt Clip Assembly	(1)
59	31-44-2554	Housing Assembly	(1)
62	42-06-2559	1/2" Detent Pin Anvil Assembly	(1)
64	-----	O-Ring	(1)

- FIG. LUBRICATION**
(Type 'J' Grease, No. 49-08-4220):
- When servicing, remove 90-95% of the existing grease prior to installing Type 'J'. Original grease maybe similar in color but not compatible with 'J'.**
- 2 Coat anvil opening in the front of the gear case with grease.
 - 3 Coat gear case washer with grease.
 - 44 Lightly coat round shaft surface of anvil with grease. Place a dab of grease in cavity at rear of anvil.
 - 54 Lightly coat the inside gear teeth of ring gear and the gear teeth of the planet gears of impacting assembly with grease.
 - 57 Coat pinion of rotor/back cap assembly with grease.

SCREW TORQUE SPECIFICATIONS				
FIG.	PART NO.	WHERE USED	SEAT TORQUE	
			(KG/CM)	(IN/LBS)
1	05-88-1255	Front Gear Case	14-17	12-14
30	06-82-6351	Rotor/Back Cap	6-8	5-6
30	06-82-6351	Right Housing-Cover	9-11	7-9
32	05-88-1015	Belt Clip	5-9	4-7

WIRING INSTRUCTIONS- one of two



STEP 1: Insert light pipe in cavity of left housing halve-support.

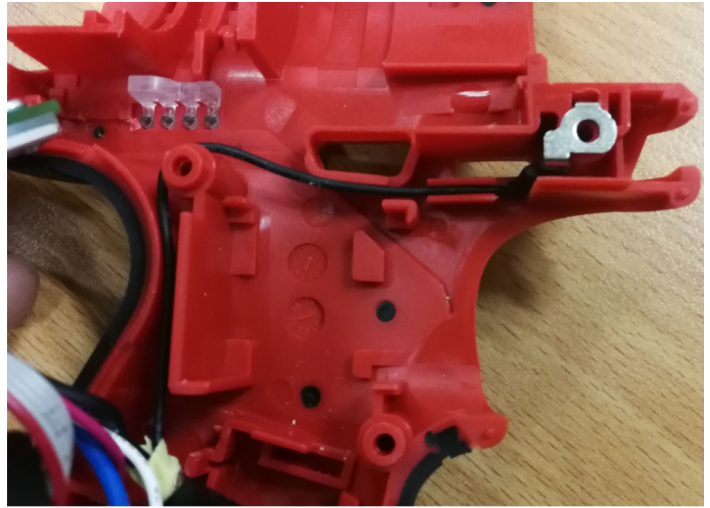

STEP 2: Assemble HV terminal over screw boss and route HV terminal wire through channels and traps as shown.

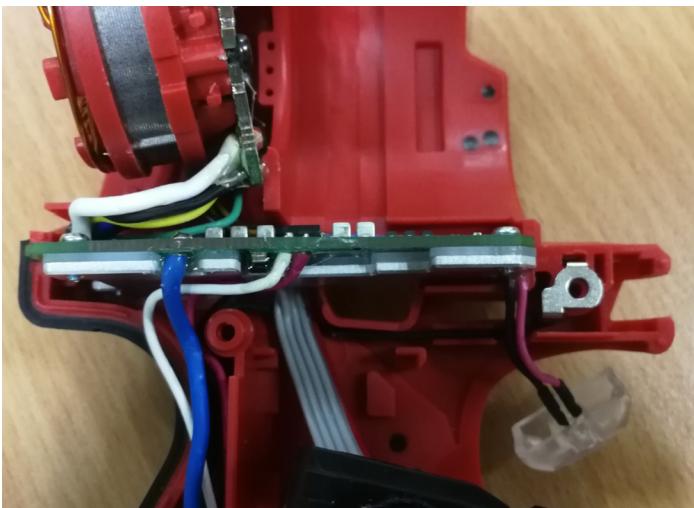

STEP 3: Assemble PCBA into corresponding housing cavity as shown.

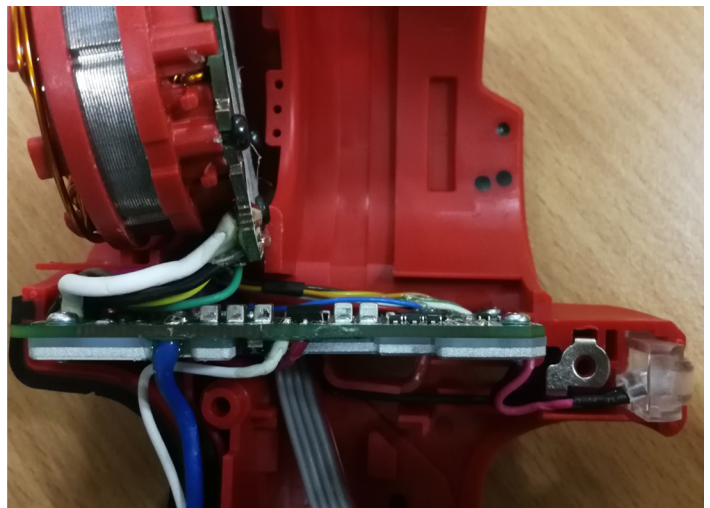

STEP 4: Install LED lens and tuck LED wires down in housing cavity, over HV terminal wire.



STEP 5: Install the pop switch into housing halve as shown. Route wires through traps being sure wires are tucked completely down.

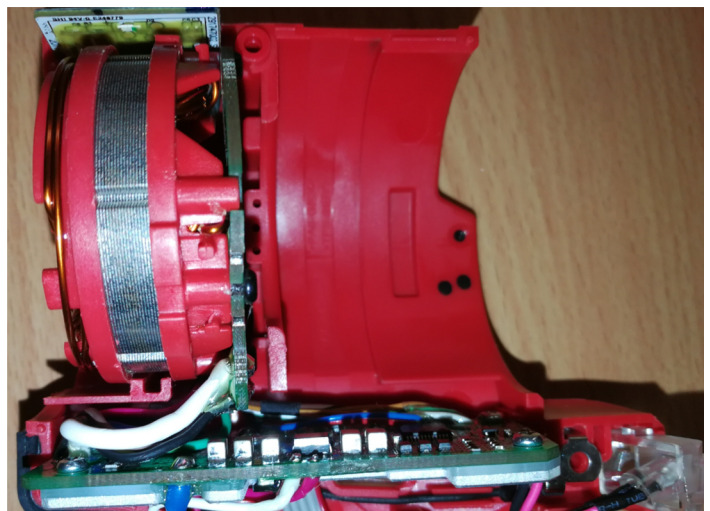

STEP 6: Assemble stator over pop switch wires. Be sure stator is seated firmly and squarely in housing halve.

WIRING INSTRUCTIONS- two of two

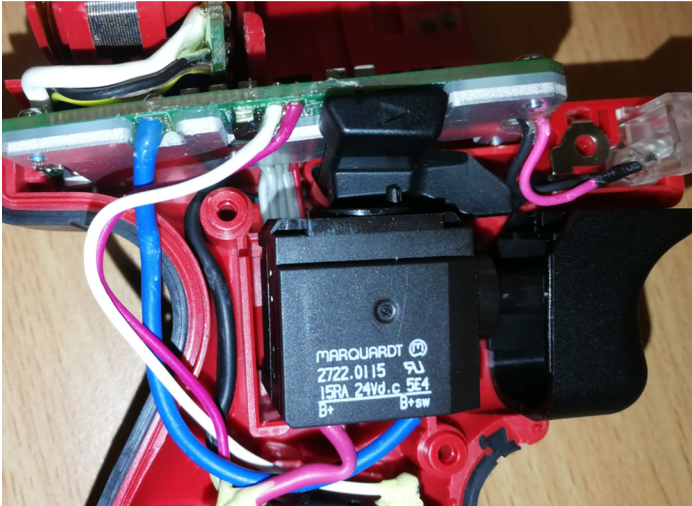

STEP 7: Install forward/reverse shuttle and on-off switch into left housing half-support. Be sure shuttle is properly seated over the forward/reverse tab on top of on-off switch.

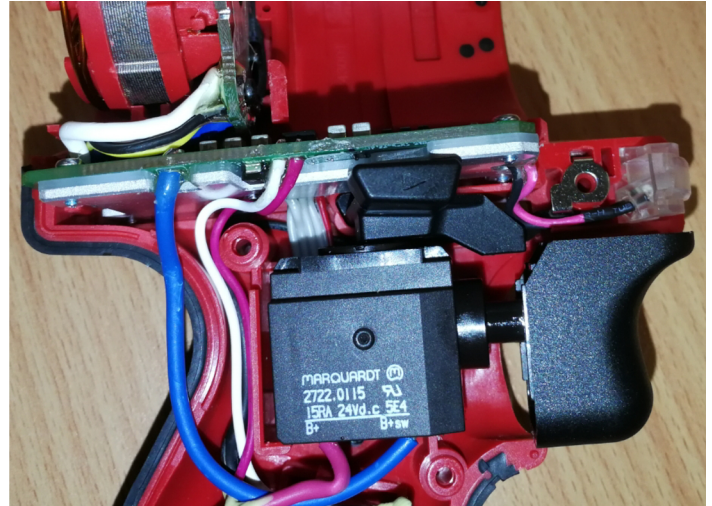

STEP 8: Route the PCBA wires connected with battery terminal into the wire channel of left housing as shown.

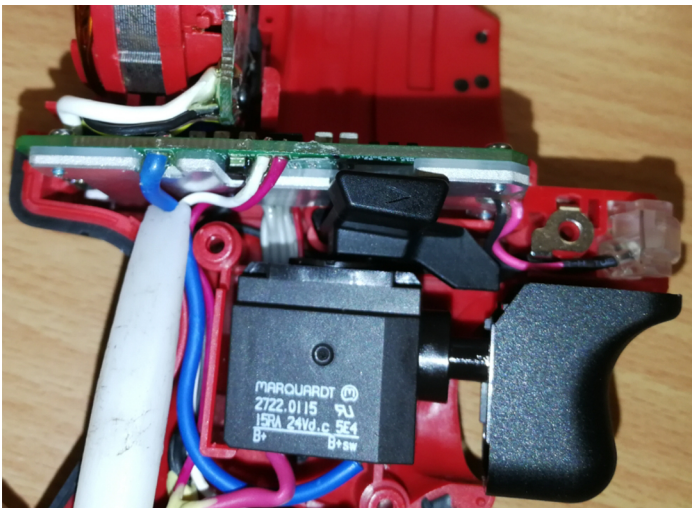

STEP 9: Use a plastic/nylon instrument to carefully press blue wire into housing cavity, over the battery terminal wires.

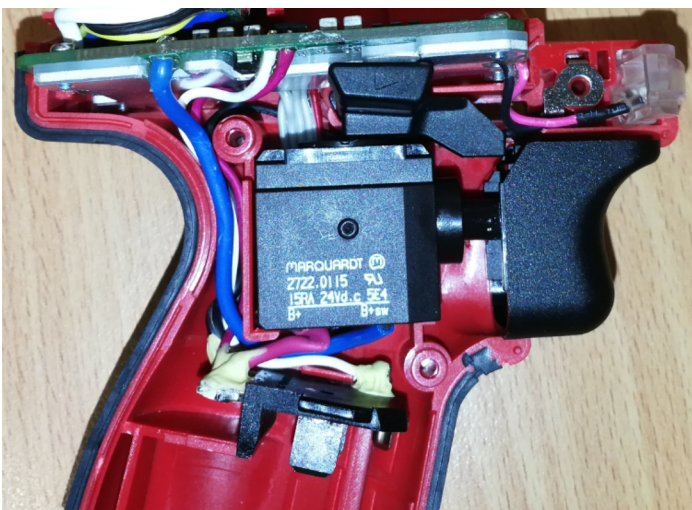

STEP 10: Install battery terminal block into the housing half being sure that it is firmly and squarely seated in the cavity.

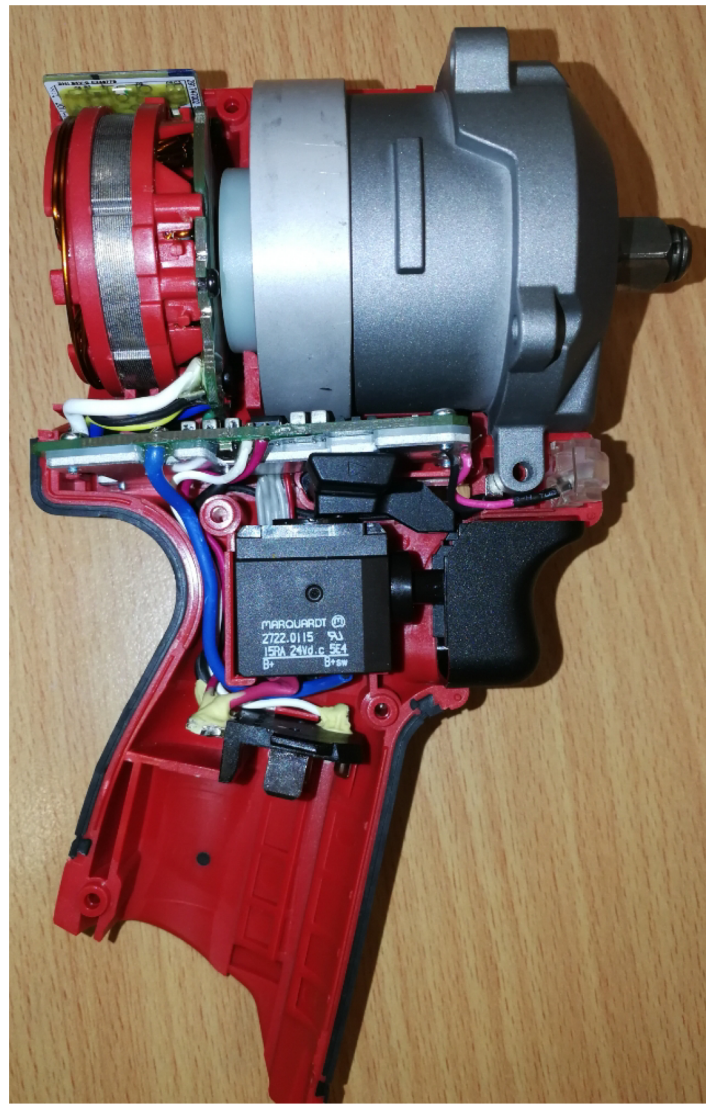

STEP 11: Assemble the gear case assembly onto the left housing half and secure with two gear case screws.

Check that all elements of electronics assembly are seated properly and that all wires are pressed completely down in wire traps and channels.

Carefully install right housing half-cover onto left housing half-support. Secure with five housing half screws and the two remaining gear case screws. Install rotor back cap assembly and secure with four screws.

Check functionality of shuttle and on-off switch before installing battery.