



SERVICE PARTS LIST

BULLETIN NO.
54-24-2410

SPECIFY CATALOG NO. AND SERIAL NO. WHEN ORDERING PARTS		REVISED BULLETIN	DATE
Cordless 12 Volt 3/8" Hammer-Drill			Feb. 2011
CATALOG NO. 2411-20	STARTING SERIAL NO. C72A	WIRING INSTRUCTION SEE REVERSE SIDE	

EXAMPLE:

00	0
----	---

 Component Parts (Small #)
 Are Included When Ordering
 The Assembly (Large #).

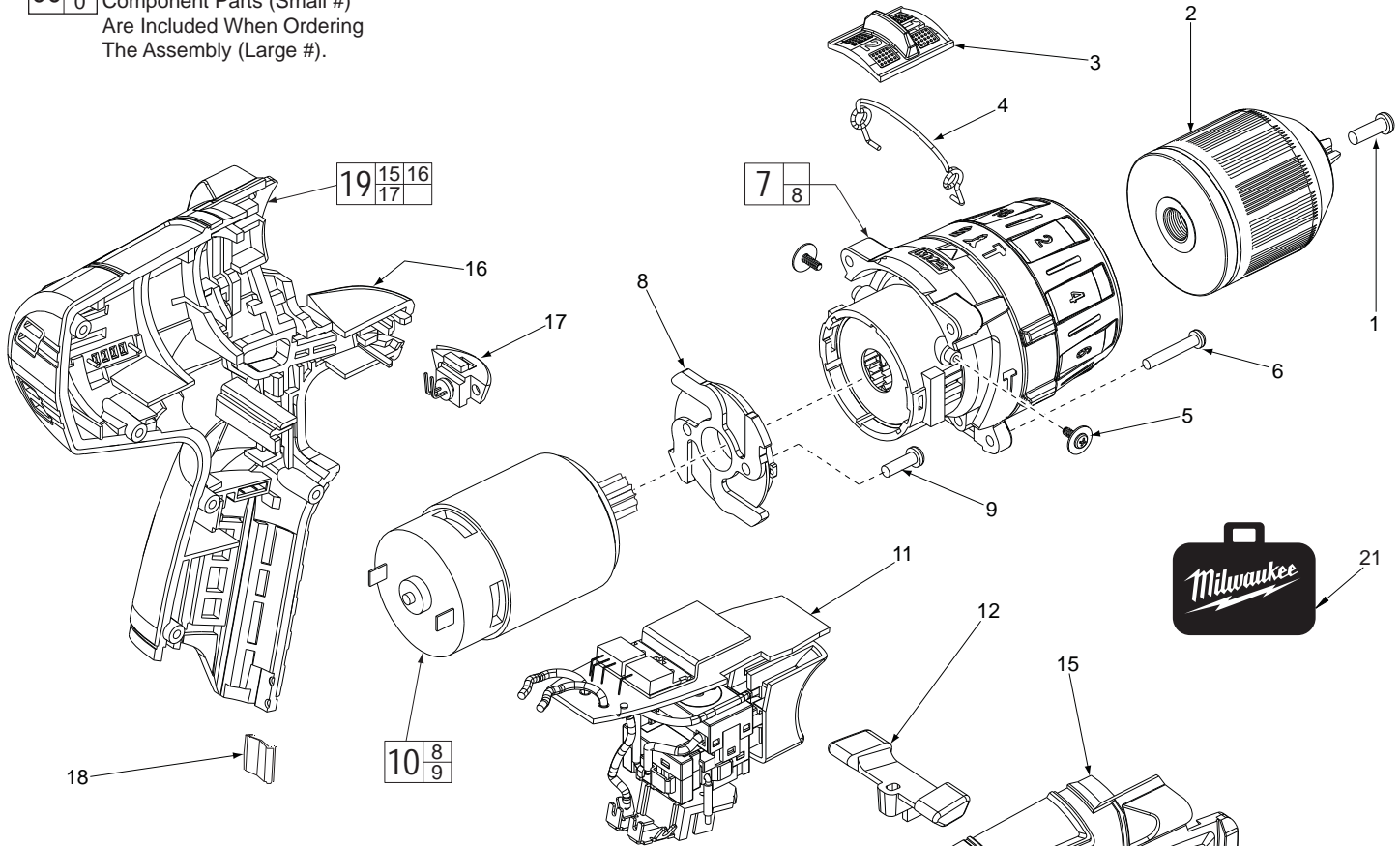
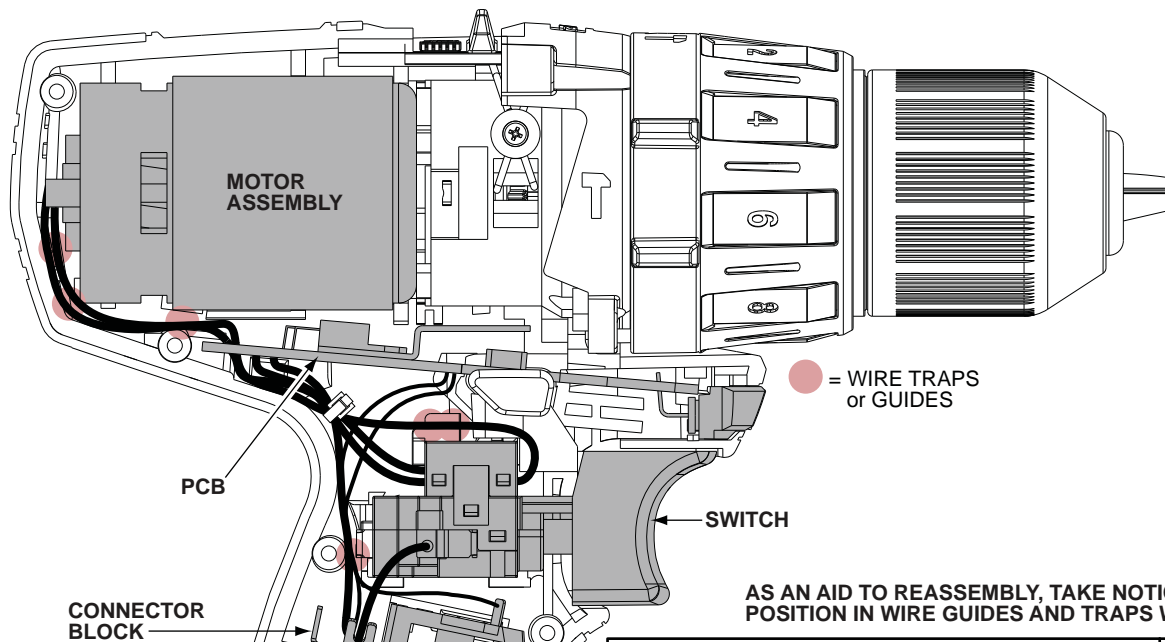

FIG.	PART NO.	DESCRIPTION OF PART	NO. REQ.
1	05-88-1680	M5 x 13.5 LH Chuck Screw	(1)
2	42-66-0530	3/8" Keyless Chuck	(1)
3	45-24-0325	Speed Slide	(1)
4	44-10-0720	Speed Selector Wire Link	(1)
5	05-81-0535	M2.3 x 4.5 Philips Shift Lever Screw	(2)
6	05-88-0780	M3 x 18 ST T-10 Gearcase Screw	(4)
7	14-30-1080	Gearcase Assembly	(1)
8	-----	Motor Mounting Plate	(1)
9	-----	Motor Mounting Screw	(2)
10	23-30-0830	Motor Assembly	(1)
11	23-66-4000	Switch Assembly	(1)
12	45-24-0275	Forward/Reverse Lever	(1)
13	12-20-2411	Service Nameplate	(1)
14	06-82-1080	M3 x 14 ST T-10 Housing Screw	(5)
15	-----	Right Housing	(1)
16	-----	Left Housing	(1)
17	31-15-1575	LED Cover	(1)
18	42-70-0055	Housing Clip	(1)
19	31-44-2580	Housing Kit	(1)
20	10-20-2885	Warning Label (Not Shown)	(1)
21	42-55-2480	Carrying Case, Optional	(1)

FIG. 7, 8, 10 NOTES:
 Service replacement gearcase assembly (7) comes with a motor mount plate (8) that must be removed and discarded when servicing. A motor mount plate already exists on the motor assembly (10).



BE CAREFUL AND AVOID PINCHING WIRES BETWEEN HANDLE HALVES WHEN ASSEMBLING.

AS AN AID TO REASSEMBLY, TAKE NOTICE OF WIRE ROUTING AND POSITION IN WIRE GUIDES AND TRAPS WHILE DISMANTLING TOOL

SLEEVED WIRES
(White, black, red, green and gray)

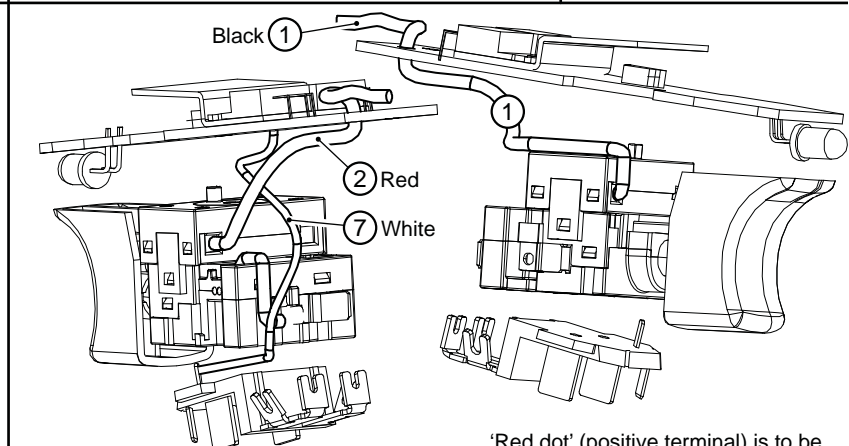
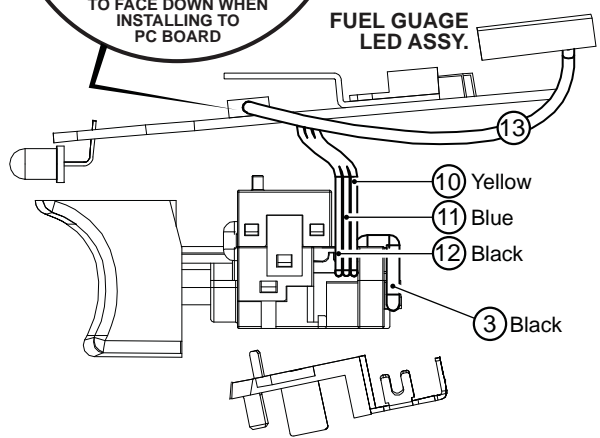
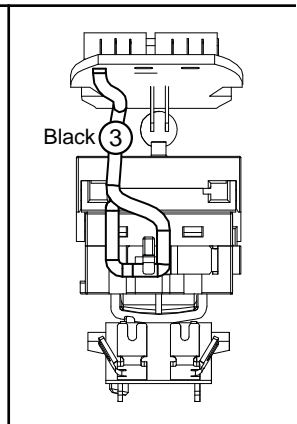
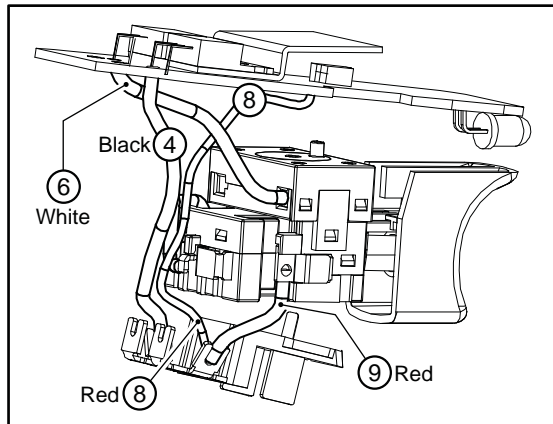
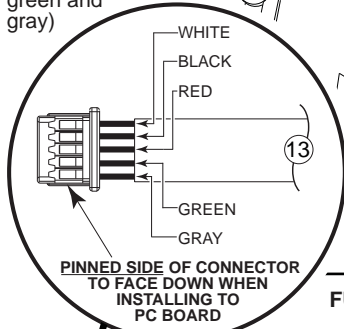

'Red dot' (positive terminal) is to be placed down in left handle half.

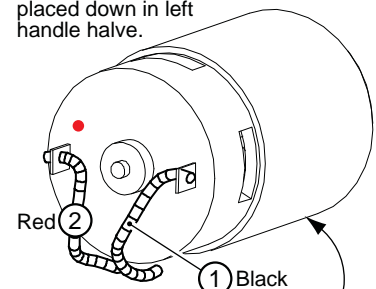

Orient motor assembly with slot to the bottom.

WIRING SPECIFICATIONS

Wire No.	Wire Color	Origin or Gauge	Length	Terminals, Connectors and 1 or 2 End Wire Preparation
1	Black	23-30-0830	----	Component of the motor assembly.
2	Red	23-30-0830	----	Component of the motor assembly.
3	Black	23-66-4000	----	Component of the switch assembly.
4	Black	23-66-4000	----	Component of the switch assembly.
6	White	23-66-4000	----	Component of the switch assembly.
7	White	23-66-4000	----	Component of the switch assembly.
8	Red	23-66-4000	----	Component of the switch assembly.
9	Red	23-66-4000	----	Component of the switch assembly.
10	Yellow	23-66-4000	----	Component of the switch assembly.
11	Blue	23-66-4000	----	Component of the switch assembly.
12	Black	23-66-4000	----	Component of the switch assembly.
13	Sleeve	23-66-4000	----	Component of the switch assembly / fuel gauge LED.