

20" DRILL PRESS (old style)

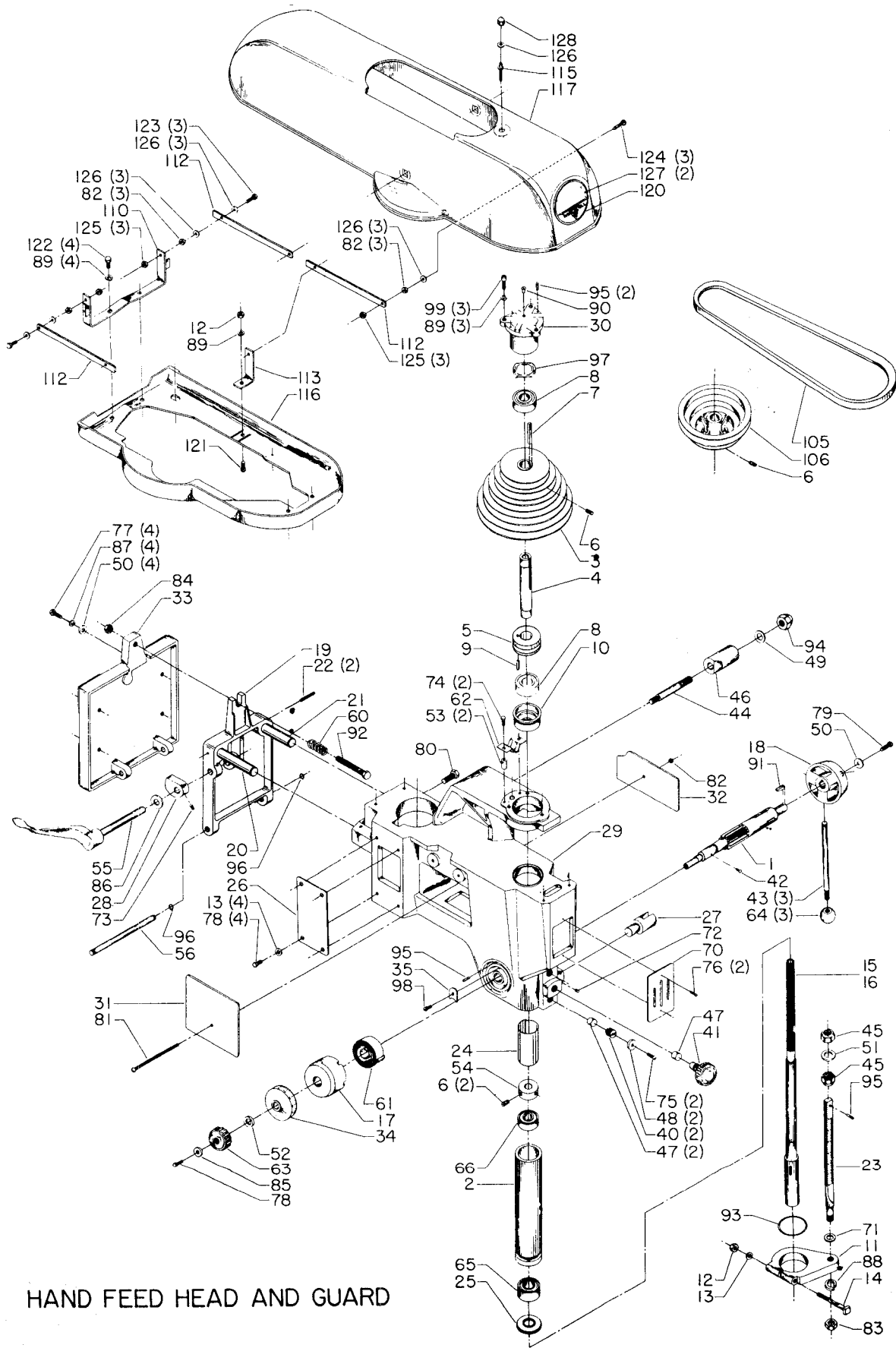

HAND FEED HEAD AND GUARD

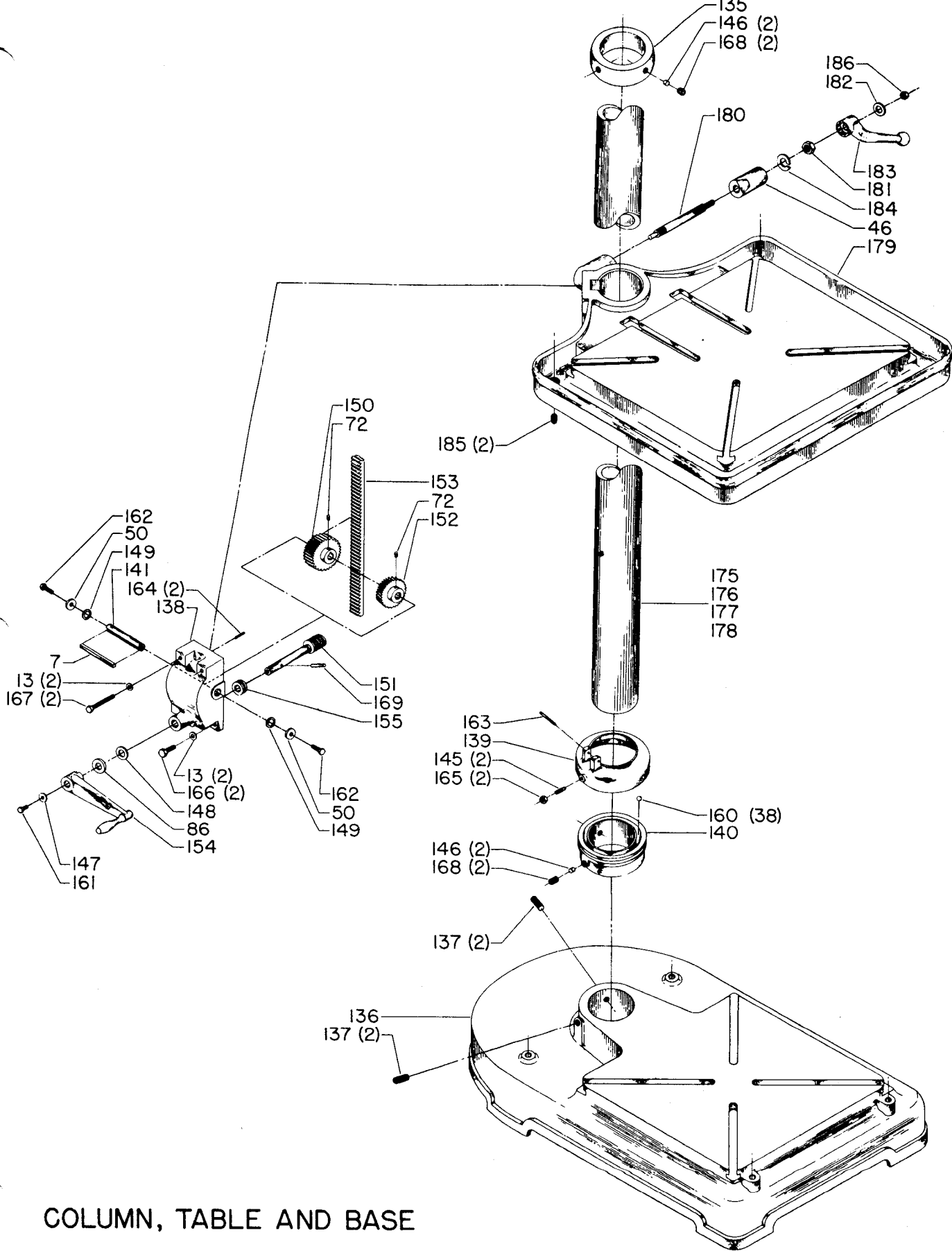

COLUMN, TABLE AND BASE

Parts List for 20-538 Type 1

| Item Number | Part Number | Description | Qty Required |
|-------------|---------------|---------------------|--------------|
| 1 | 000000-00 | No Longer Available | 1 |
| 2 | 000000-00 | No Longer Available | 1 |
| 3 | 000000-00 | No Longer Available | 1 |
| 4 | 401041065004 | SHAFT | 1 |
| 5 | 000000-00 | No Longer Available | 1 |
| 6 | 901041500217 | SET SCREW | 2 |
| 7 | 927030102668 | KEY | 1 |
| 8 | 920040205360 | BEARING | 1 |
| 9 | 905010106714 | ROLL PIN | 1 |
| 10 | 000000-00 | No Longer Available | 1 |
| 11 | 000000-00 | No Longer Available | 1 |
| 12 | 902010101300S | HEX NUT | 1 |
| 13 | 904010101620S | WASHER | 8 |
| 17 | 000000-00 | No Longer Available | 1 |
| 18 | 000000-00 | No Longer Available | 1 |
| 19 | 000000-00 | No Longer Available | 1 |
| 22 | 000000-00 | No Longer Available | 2 |
| 23 | 000000-00 | No Longer Available | 1 |
| 25 | 401040365001 | FLINGER COLLAR | 1 |
| 26 | 401040315005 | COVER PLATE | 1 |
| 27 | 000000-00 | No Longer Available | 1 |
| 28 | 000000-00 | No Longer Available | 1 |
| 29 | 000000-00 | No Longer Available | 1 |
| 30 | 000000-00 | No Longer Available | 1 |
| 31 | 000000-00 | No Longer Available | 1 |
| 32 | 000000-00 | No Longer Available | 1 |
| 33 | 000000-00 | No Longer Available | 1 |

Parts List for 20-538 Type 1

| Item Number | Part Number | Description | Qty Required |
|-------------|---------------|----------------------|--------------|
| 34 | 000000-00 | No Longer Available | 1 |
| 35 | 000000-00 | No Longer Available | 1 |
| 40 | 000000-00 | No Longer Available | 2 |
| 42 | 952011213274 | SPRING PIN | 1 |
| 43 | 000000-00 | No Longer Available | 1 |
| 44 | 000000-00 | No Longer Available | 1 |
| 45 | 000000-00 | No Longer Available | 1 |
| 47 | 000000-00 | No Longer Available | 2 |
| 49 | 000000-00 | No Longer Available | 1 |
| 50 | 904100315381 | WASHER | 4 |
| 51 | 000000-00 | No Longer Available | 1 |
| 52 | 000000-00 | No Longer Available | 1 |
| 54 | 904101812409 | COLLAR | 1 |
| 55 | 000000-00 | No Longer Available | 1 |
| 56 | 000000-00 | No Longer Available | 1 |
| 60 | 000000-00 | No Longer Available | 1 |
| 61 | 928080121766 | RETURN SPRING | 1 |
| 63 | 000000-00 | No Longer Available | 1 |
| 64 | 931010114796 | KNOB - SCREW ON | 3 |
| 70 | 402040310001S | SWITCH OPENING COVER | 1 |
| 71 | 000000-00 | No Longer Available | 1 |
| 72 | 491950-00 | SET SCREW | 1 |
| 73 | 901041500231S | SET SCREW | 1 |
| 74 | 901020100501 | MACHINE SCREW | 2 |
| 75 | 901020100503 | MACHINE SCREW | 2 |
| 77 | 901010600602 | CAP SCREW | 4 |
| 78 | 901010600605 | CAP SCREW | 4 |

Parts List for 20-538 Type 1

| Item Number | Part Number | Description | Qty Required |
|-------------|---------------|---------------------|--------------|
| 79 | 901010600607S | SCREW | 1 |
| 80 | 000000-00 | No Longer Available | 1 |
| 81 | 901020100912 | MACHINE SCREW | 1 |
| 82 | 489026-00 | HEX NUT | 6 |
| 83 | 902010201226S | NUT | 1 |
| 84 | 902010201266 | HEX JAM NUT | 1 |
| 85 | 491956-00 | WASHER | 1 |
| 86 | 904010101622 | STEEL WASHER | 1 |
| 87 | 904020101703S | LOCK WASHER | 4 |
| 88 | 000000-00 | No Longer Available | 1 |
| 89 | 904020101703S | LOCK WASHER | 7 |
| 90 | 907000002486 | OIL HOLE COVER | 1 |
| 91 | 927030102662 | KEY | 1 |
| 92 | 000000-00 | No Longer Available | 1 |
| 93 | 000000-00 | No Longer Available | 1 |
| 94 | 000000-00 | No Longer Available | 1 |
| 95 | 905010106715S | ROLL PIN | 2 |
| 96 | 904150107018S | RING | 1 |
| 97 | 000000-00 | No Longer Available | 1 |
| 98 | 901030408015S | CAP SCREW | 1 |
| 99 | 901030408016S | CAP SCREW | 3 |
| 110 | 000000-00 | No Longer Available | 1 |
| 113 | 401040145007 | FRONT BRACKET | 1 |
| 116 | 000000-00 | No Longer Available | 1 |
| 117 | 000000-00 | No Longer Available | 1 |
| 121 | 901020100506 | MACHINE SCREW | 1 |
| 122 | 489047-00 | CAP SCREW | 4 |

Parts List for 20-538 Type 1

| Item Number | Part Number | Description | Qty Required |
|-------------|---------------|---------------------|--------------|
| 123 | 901010600626S | CAP SCREW | 3 |
| 124 | 901110200821 | CARRIAGE BOLT | 3 |
| 125 | 902012101079 | LOCK NUT | 6 |
| 126 | 904010101614S | STEEL WASHER | 9 |
| 135 | 401040895001 | STOP COLLAR | 1 |
| 136 | 000000-00 | No Longer Available | 1 |
| 137 | 000000-00 | No Longer Available | 1 |
| 138 | 000000-00 | No Longer Available | 1 |
| 139 | 000000-00 | No Longer Available | 1 |
| 140 | 000000-00 | No Longer Available | 1 |
| 141 | 401041065007 | GEAR SHAFT | 1 |
| 145 | 901043804562 | GUIDE SCREW | 2 |
| 146 | 000000-00 | No Longer Available | 4 |
| 147 | 904010317712S | WASHER | 1 |
| 148 | 904070714214 | WASHER | 1 |
| 149 | 904070714230 | WASHER | 1 |
| 150 | 401043515003 | GEAR ASSY | 1 |
| 151 | 401040515002 | WORM GEAR | 1 |
| 152 | 401043515002 | GEAR ASSY | 1 |
| 154 | 000000-00 | No Longer Available | 1 |
| 155 | 000000-00 | No Longer Available | 1 |
| 160 | 921010100031 | STEEL BALL | 38 |
| 161 | 901010600651 | CAP SCREW | 1 |
| 162 | 901010600663 | CAP SCREW | 1 |
| 163 | 000000-00 | No Longer Available | 1 |
| 164 | 905020105030 | GROOVE PIN | 2 |
| 165 | 902010205435S | JAM NUT | 2 |

Parts List for 20-538 Type 1

| Item Number | Part Number | Description | Qty Required |
|-------------|---------------|----------------------|--------------|
| 166 | 901010600649S | CAP SCREW | 2 |
| 167 | 901010605770 | CAP SCREW | 2 |
| 168 | 000000-00 | No Longer Available | 2 |
| 169 | 905020506862 | GROOVE PIN | 1 |
| 177 | 20-627 | 3-3/4 X 66 IN COLUMN | 1 |
| 180 | 952011413285 | STUD | 1 |
| 181 | 902012101084 | 5/8FLEXLCKNUT | 1 |
| 184 | 904020101713 | LOCK WASHER | 1 |
| 185 | 000000-00 | No Longer Available | 2 |
| 186 | 852573 | NUT | 1 |
| 187 | 491956-00 | WASHER | 1 |