

180 Chain Saw UT-10721-B 10721-B-UT 180 Chain Saw UT-10721-B 180 Chain Saw - Engine Housing

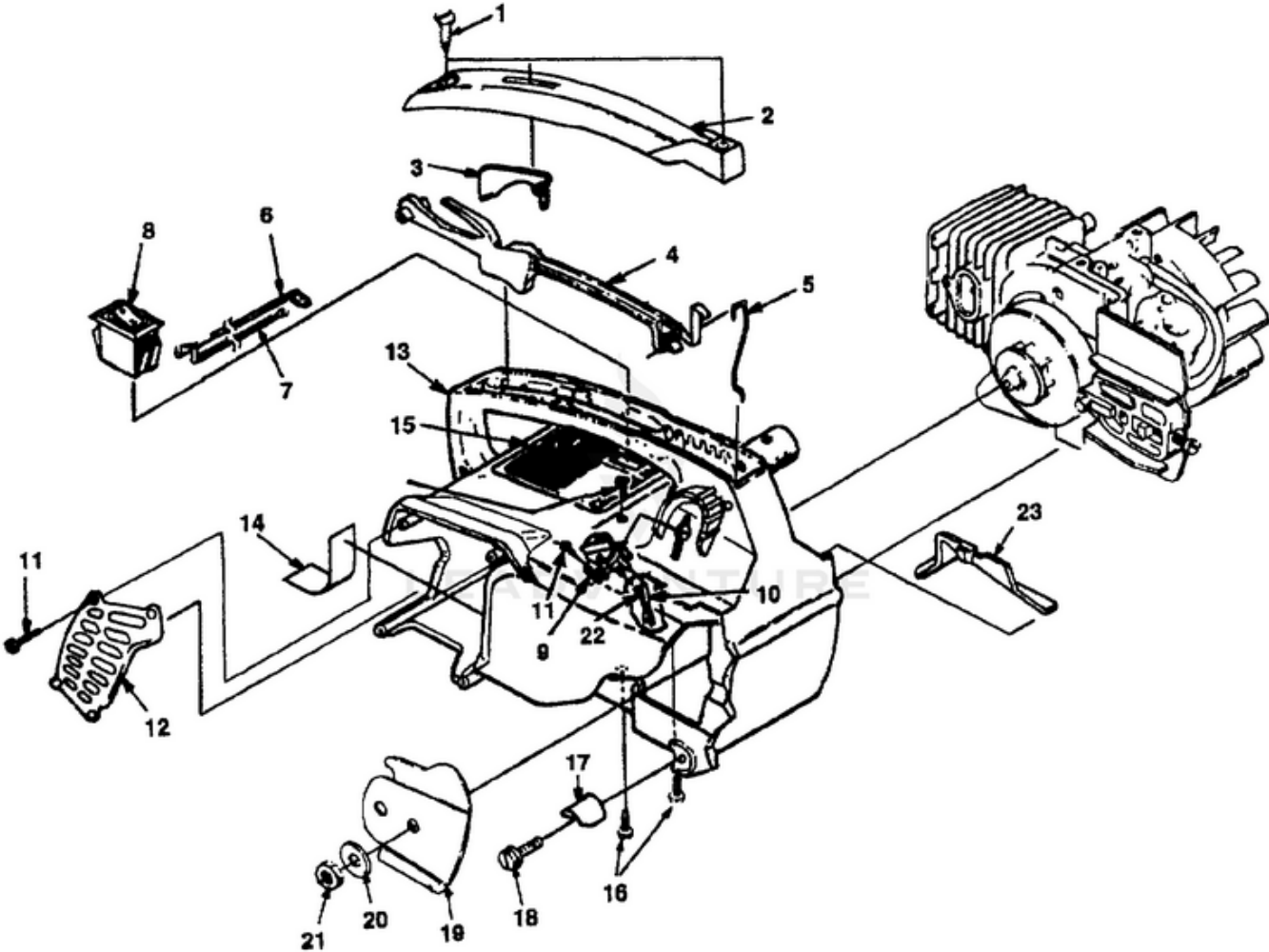

Rendered by LeadVenture, Inc.

Ref #	Part #	Description	Qty
1	94065	SCREW-Pan, plastite (#10-16 X 3/4")	2
2	02495	COVER-Handle	1
3	02493	LOCK-Trigger	1
4	02492A	TRIGGER	1
5	02501	ROD-Throttle	1
6	A02482	LEAD-w/Flag Term.	1
7	A02434	LEAD-w/Ring Term.	1
8	02491	SWITCH	1
9	A01147	OIL VALVE	1
10	7031017	TUBING-Rubber (4 1/4")	
11	82528	SCREW-Pan plastite (#6 X 3/8")	5
12	02765	SHIELD-Muffler	1
13	A01232	HOUSING-Engine	1
14	95615	TAPE	2
15	02490A	DECAL-Warning	1
16	82538	SCREW-Torx, taptite (10-24 X 3/4")	4
17	95212	STOP-Chain	1
18	82563	SCREW-Torx, plastite (#10 X 3/4")	1
19	69360A	PLATE-Guide Bar	1
20	69309A	WASHER-Flat	1
21	810652	NUT-Hex	1
22	7031032	TUBING Rubber (8")	1
23	02481	COVER- Air Filter	1

180 Chain Saw UT-10721-B 10721-B-UT 180 Chain Saw UT-10721-B 180 Chain Saw - Engine Internals

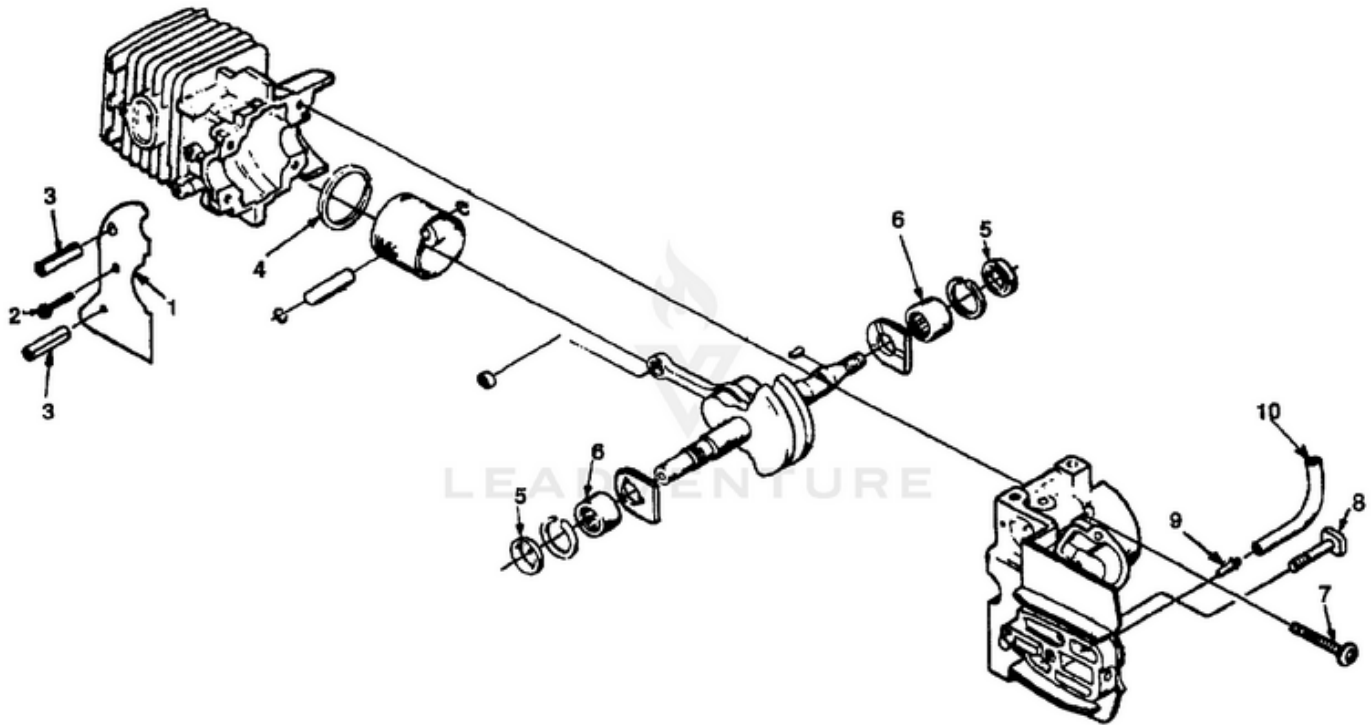

Rendered by LeadVenture, Inc.

Ref #	Part #	Description	Qty
1	02639	SAW DUST SHIELD	1
2	93932	SCREW- Tapping (#6-32 x 5/16")	1
3	70763	PIN- Roll (5/32 x 1 1/8")	2
	A001321	SHORT BLOCK (XL, 180)	1
4	93165	RING- Piston	1
5	94638	SEAL- Shaft	2
6	12530	BEARING- Needle	2
7	82567	SCREW- Torx Pan Hd. (10-24 x 1 1/8")	4
8	69195	BOLT-Guide Bar	1
9	94619	FITTING- Tube	1
	A01105	SHORT BLOCK (192, Super 2, 200, Super 2 SL))	1
	93165	RING-Piston	1
	94638	SEAL- Shaft	2
	12530	BEARING- Needle	2
	82567	SCREW- Torx Pan Hd. (10-24 x 1 1/8")	4
	69195	BOLT- Guide Bar	1
	94619	FITTING- Tube	1
10	7031017	TUBING- Rubber (Oil Line) (4 1/4")	1
	7031099	TUBING- Rubber (Oil Line) (10 Ft. Length)	1

180 Chain Saw UT-10721-B 10721-B-UT 180 Chain Saw UT-10721-B 180 Chain Saw - Handguard & Chain Brake

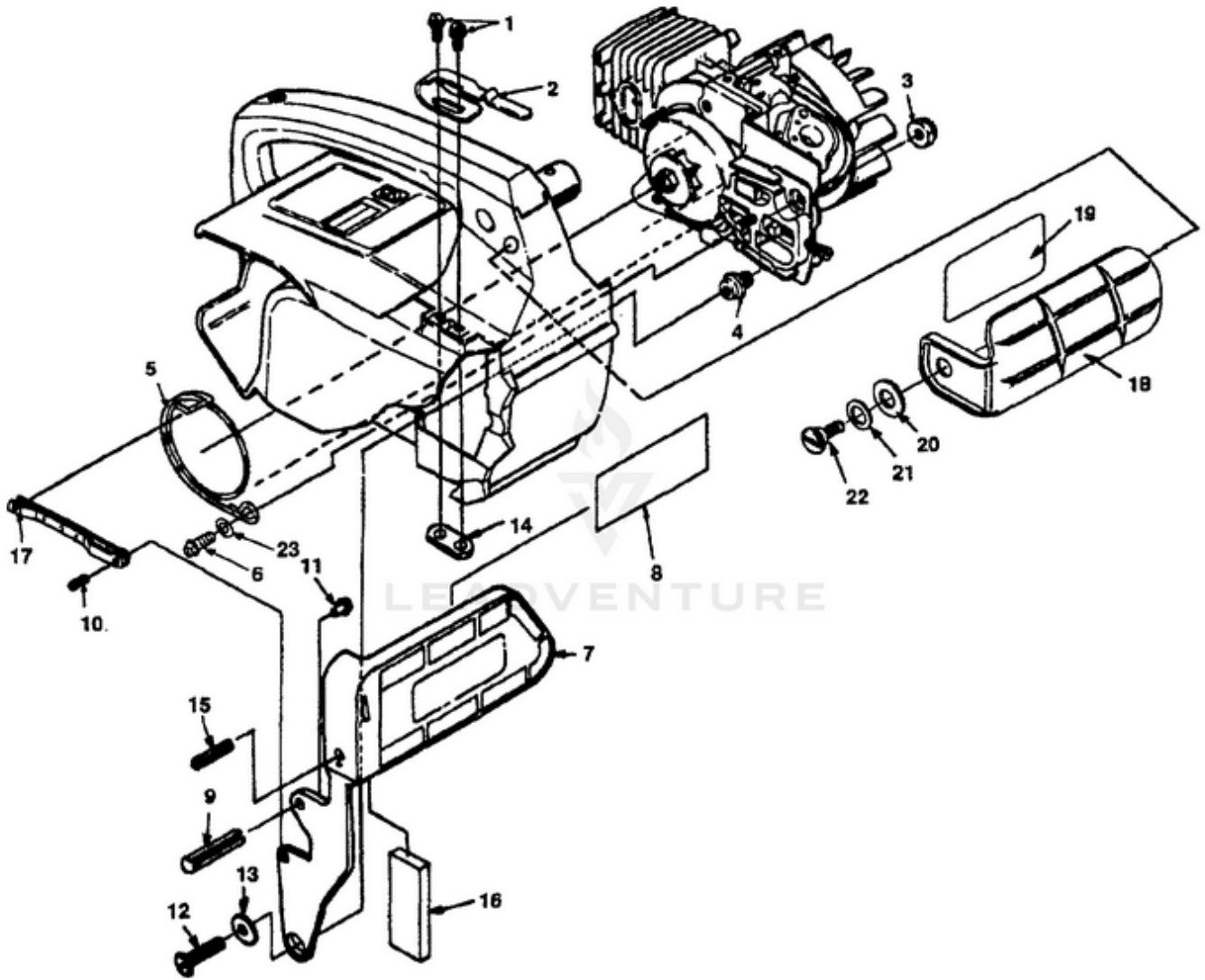

Rendered by LeadVenture, Inc.

Ref #	Part #	Description	Qty
1	88066	SCREW-Hex Hd. w/Washer (8-32 X 1/2")	2
2	02635	CLIP-Retaining	1
3	81124A	NUT-Hex, Jam	1
4	70636	POST-Chain Brake	1
5	70637C	BAND-Brake	1
6	82538	SCREW-Thread Form (10-24 x 3/4")	1
7	A03061A	HANDGUARD & LEVER	1
8	02661	DECAL-Safety	1
9	JA461383	PIN-Roll (3/16 X 1")	1
10	95395A	PIN-Roll	1
11	82367	SCREW-Drive	1
12	82166	SCREW-Machine, Pan Hd. (10-32 X 1/2")	1
13	70632	WASHER-Flat	1
14	02637	NUT-Weld	1
15	JA461361	PIN-Roll	1
16	02462	WEIGHT-Handle	1
17	A70767	PIVOT-Link	1
18	A70796C	HANDGUARD KIT	1
19	02661	DECAL-Handguard	1
20	95694	WASHER-Curve Spring	1
21	96102	WASHER-Flat	1
22	95714	SCREW-Shoulder	1
23	84008	WASHER- Flat (#10)	1

180 Chain Saw UT-10721-B 10721-B-UT 180 Chain Saw UT-10721-B 180 Chain Saw - Intake, Ignition, Muffler & Clutch

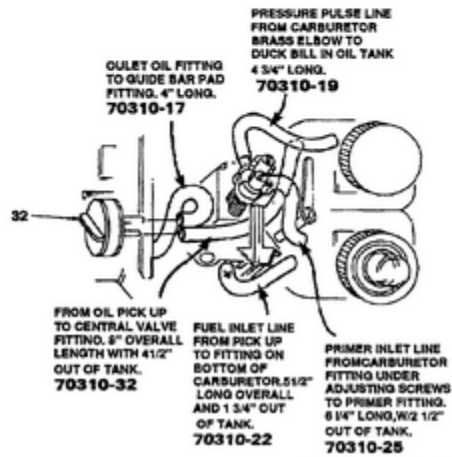
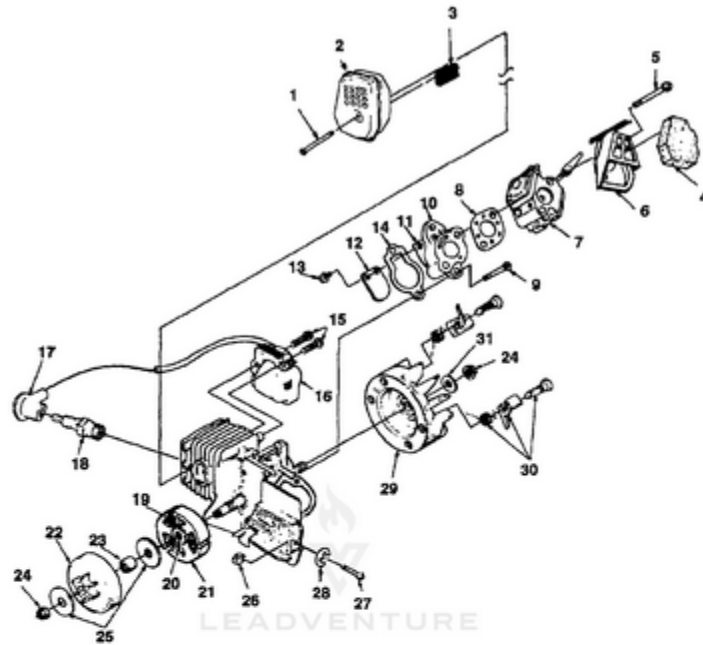

Rendered by LeadVenture, Inc.

Ref #	Part #	Description	Qty
1	93460	SCREW-Machine Hex Sems (#8 -32 X 3/4")	1
2	A02459	MUFFLER	1
3	02458	SCREEN-Spark Arrestor	1
4	02500	FILTER-Air	1
5	00167	SCREW-Thread Forming	2
6	02491A	BOX-Air Filter	1
7	A01373	CARBURETOR (Zama)	1
8	02488	GASKET-Carburetor	1
9	82589	SCREW-Plastite, (10-14 X 1")	2
10	A02499	HEAT DAM	1
11	95983	REED	1
12	03205	STOP-Reed	1
13	82498	SCREW-Hex Taptite (4-40 X 3/8")	2
14	02453	GASKET-Intake Manifold	1
15	82540	SCREW-Thread Forming (8-32 X 1")	2
16	94711CS	MODULE-Ignition	1
17	A33055	TERMINAL HIGH TENS(P TBO	1
18	96169S	SPARK PLUG (Champion DJ7Y)	1
	79252	SPARK PLUG (Champion RDJ7Y)	1
19	03961	SPRING-Clutch	3
20	79221	SPIDER-Clutch	1
21	79222A	SHOE-Clutch	3
22	A95653C	SPROCKET & DRUM	1
23	70277	BEARING	1
24	81229	NUT-Rotor (5/16-24)	2
25	95299	WASHER-Thrust	2
26	692542	PIN-Adjusting	1
27	A00440	SCREW & E-RING KIT	1
28	93574	E-RING	1
29	A04158	ROTOR & STARTER PAWL	1
30	A70285E	STARTER PAWL KIT	1
31	84065	WASHER-(5/16")	1
32	A01147	OIL VALVE	1

180 Chain Saw UT-10721-B 10721-B-UT 180 Chain Saw UT-10721-B 180 Chain Saw - Starter & Tanks

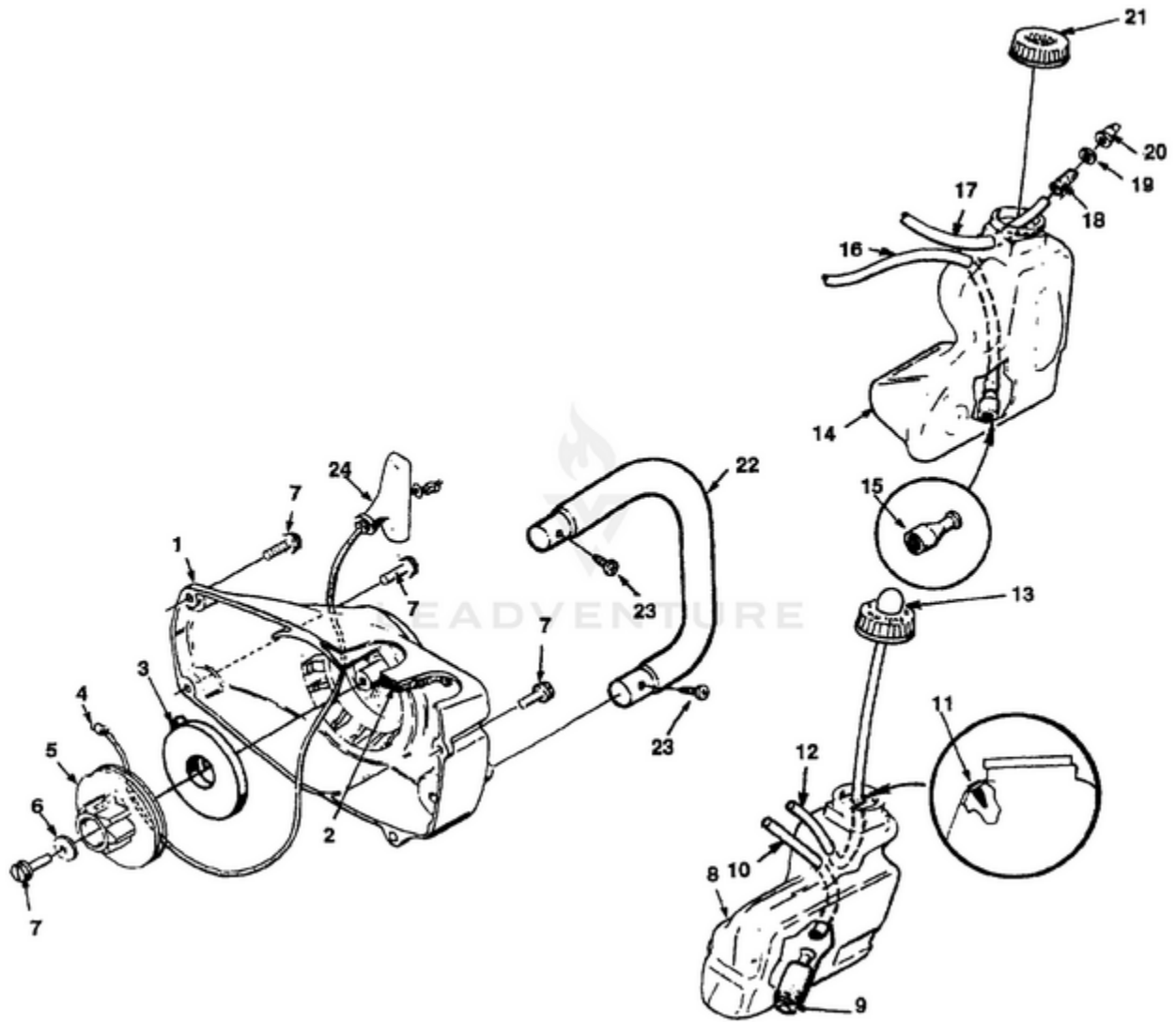

Rendered by LeadVenture, Inc.

Ref #	Part #	Description	Qty
1	A02562B	STARTER HOUSING ASSY.	1
2	69443	FILTER	1
3	A97908	SPRING & CONTAINER	1
4	9789901	ROPE-Starter (46")	1
	98052A	ROPE- Starter (250 Ft. Reel)	1
5	97768A	PULLEY Starter	1
6	94062	WASHER-Retaining	1
7	82563	SCREW-Torx (#10 x 3/4")	5
8	A027641	FUEL TANK	1
9	49422	FILTER- Fuel	1
10	7031022	LINE-Fuel (5 1/2")	1
11	08819	VALVE-Check	1
12	7031025	TUBING-Return 6 1/4"	1
	7031099	TUBING- Rubber (10 Ft. Length)	1
13	A01372A	PRIMER & CAP	1
14	A027631	OIL TANK	1
15	A68593	FINDER-Oil	1
16	7031032	TUBING-Rubber (8")	1
17	7031019	TUBING-Rubber (4 3/4")	1
18	69659B	FITTING-Oil	1
19	83004	WASHER- Lock	1
20	98819	VALVE-Check	1
21	A97230A	OIL CAP	1
22	02496	HANDLE BAR	1
23	94065	SCREW- Pan Plastite (#10-16 x 3/4")	2
24	02264	GRIP-Starter	1

180 Chain Saw UT-10721-B 10721-B-UT 180 Chain Saw UT-10721-B 180 Chain Saw - Carburetor & Accessories

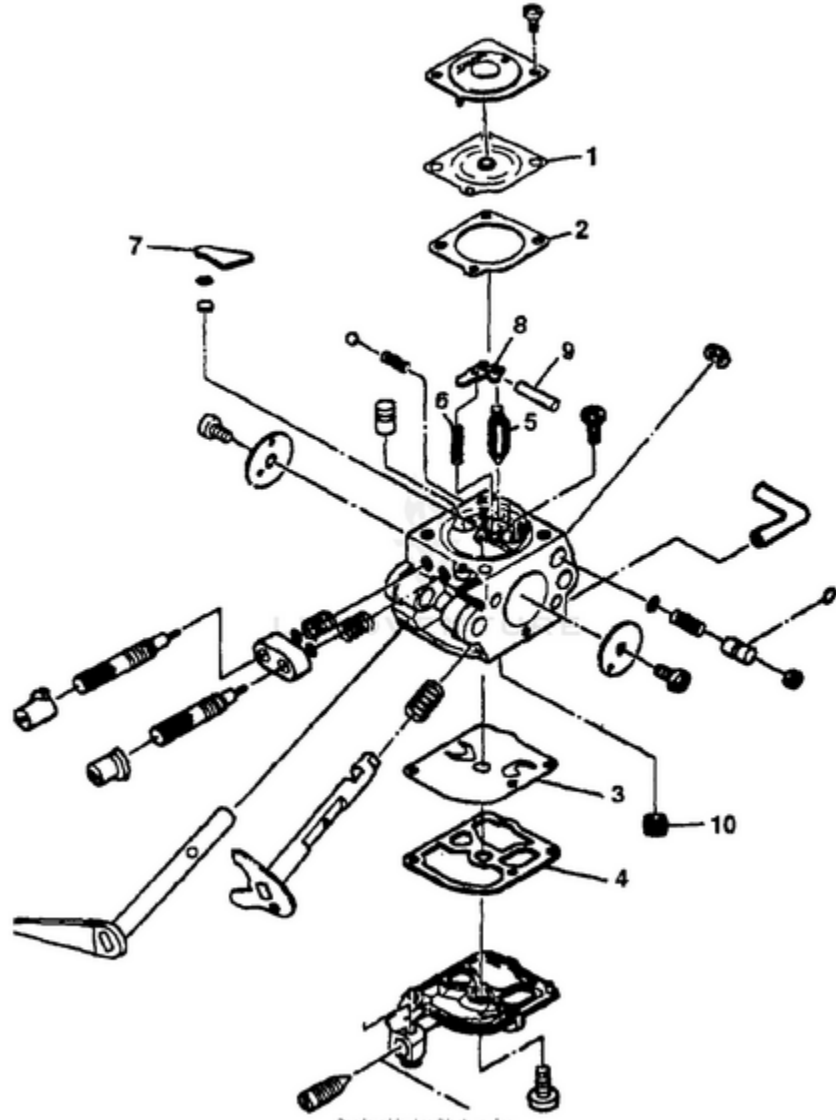

Rendered by LeadVenture, Inc.

Ref #	Part #	Description	Qty
	A03904	DIAPH&GSKT KIT(250)	1
	A01375	Repair Kit	1
1			1
2			1
3			1
4			1
5			1
6			1
7			1
8			1
9			1
10			1