

EARLY MODELS ONLY

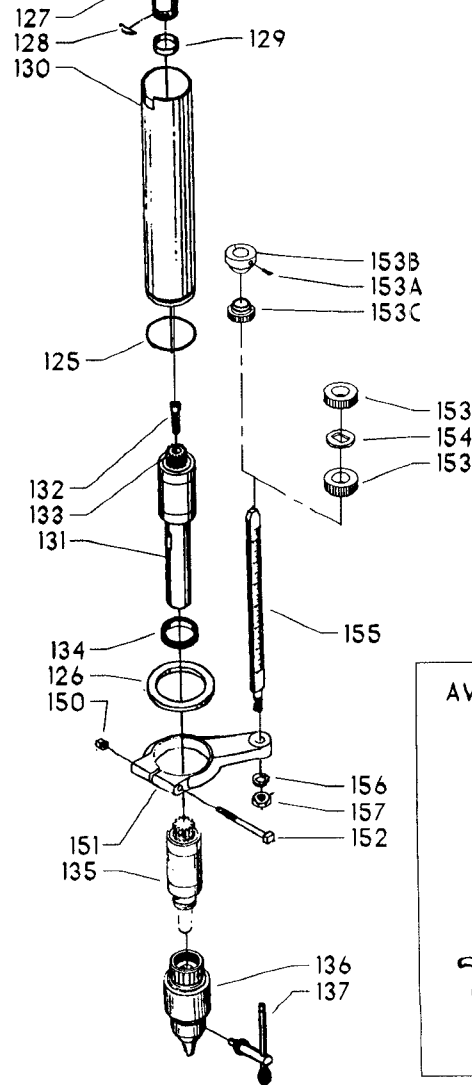

AVAILABLE AS AN ACCESSORY

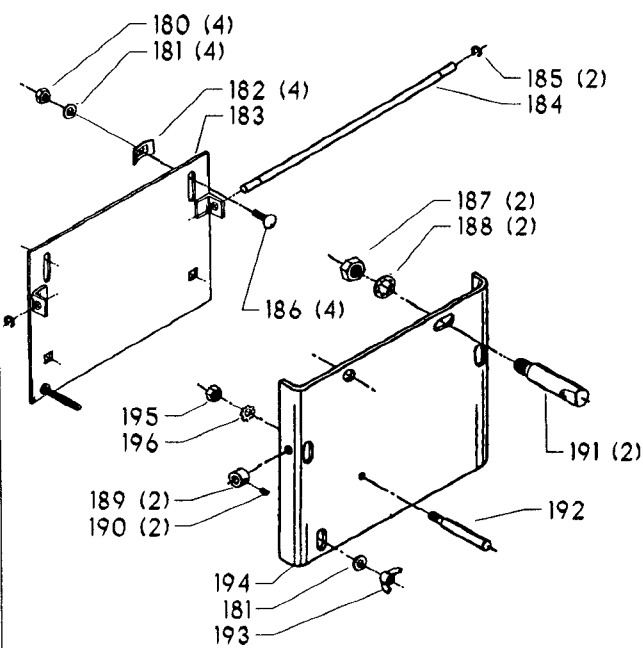
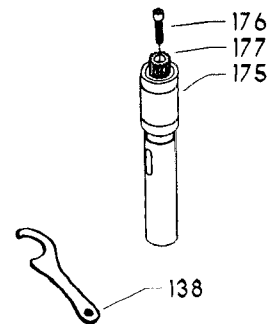

## Parts List for 17-463 Type 2

Item Number	Part Number	Description	Qty Required
1	000000-00	No Longer Available	1
1	402007520001	WARNING LABEL	1
2	000000-00	No Longer Available	2
3	901021207504S	MACHINE SCREW	1
4	901064502250S	DRIVE SCREW	2
5	402051370001	NAMEPLATE	1
6	000000-00	No Longer Available	2
7	902012101079	LOCK NUT	4
8	489026-00	HEX NUT	4
9	904010101614S	STEEL WASHER	4
10	000000-00	No Longer Available	2
11	901010600626S	CAP SCREW	2
12	902010101300S	HEX NUT	2
13	904010101620S	WASHER	2
14	401043145010	REAR BRACKET	1
15	402070545001	LOWER GUARD	1
16	901020100506	MACHINE SCREW	2
17	401040145007	FRONT BRACKET	1
18	901010600605	CAP SCREW	1
20	000000-00	No Longer Available	1
21	000000-00	No Longer Available	1
21	49-051	V BELT-REPLACES 501	1
22	000000-00	No Longer Available	1
23	901041500206	SET SCREW	1
24	41-825	HS PULY-7/8B-5ST	1
25	901041500206	SET SCREW	1
26	904150131024	RET RING	2

## Parts List for 17-463 Type 2

Item Number	Part Number	Description	Qty Required
27	000000-00	No Longer Available	1
28	1200037	MOTOR PLATE ASSY	1
28	1200040	MOTOR PLATE ASSY	1
29	901110200834S	CARRIAGE BOLT	4
30	902030002951	SPEED NUT	4
31	902010205435S	JAM NUT	1
32	1200035	MOTOR PLATE ASSY	1
33	902040101403	WING NUT	1
34	901010600649S	CAP SCREW	2
35	902030002951	SPEED NUT	2
36	904010101620S	WASHER	4
37	904010101620S	WASHER	1
38	902010101300S	HEX NUT	4
40	402073575022	HEAD ASSY	1
41	402070205005	CAP	1
42	000000-00	No Longer Available	1
43	901010603114	CAP SCREW	1
44	000000-00	No Longer Available	2
45	901041900207S	SET SCREW	1
46	000000-00	No Longer Available	1
47	904070105575	WASHER	1
48	000000-00	No Longer Available	1
49	402070515002	COMPOUND GEAR	1
50	000000-00	No Longer Available	1
51	901041500206	SET SCREW	1
52	901202416107	HEX HD SCR	3
53	000000-00	No Longer Available	1

## Parts List for 17-463 Type 2

Item Number	Part Number	Description	Qty Required
54	000000-00	No Longer Available	1
55	920040215116	BEARING	1
56	926010516349	PULLEY	1
57	920040205360	BEARING	1
58	000000-00	No Longer Available	1
58	402071065005	SPINDLE	1
59	927010102600	WOODRUFF KEY	1
60	928060107352	SPRING WASHER	1
61	927030102661	KEY	1
62	952011213274	SPRING PIN	1
63	402071065026	PINION SHAFT	1
63	402074065018	PINION ASSY	1
64	000000-00	No Longer Available	1
65	905010106745	ROLL PIN	1
66	000000-00	No Longer Available	1
67	1641138	KNOB	3
67	1641138	KNOB	3
68	902012009706	HEX NUT	1
69	901030131026S	CAP SCREW	1
70	961010107473	PLUG	1
71	905010106715S	ROLL PIN	1
72	000000-00	No Longer Available	1
73	901030408015S	CAP SCREW	1
74	928080121766	RETURN SPRING	1
75	000000-00	No Longer Available	1
75	402073885002	STOP ASSY	1
76	904010101622	STEEL WASHER	1

## Parts List for 17-463 Type 2

Item Number	Part Number	Description	Qty Required
77	902010201226S	NUT	1
102	901041500205	SET SCREW	1
103	402054065008	WORM SHAFT	1
104	000000-00	No Longer Available	1
105	930059914787	BALL CRANK	1
106	901041500206	SET SCREW	1
107	901020100912	MACHINE SCREW	1
108	960030102413	LUBE PLATE	1
109	901010600633	CAP SCREW	1
110	902010105437	HEX NUT	1
111	000000-00	No Longer Available	1
112	901061203019	SCREW	1
113	000000-00	No Longer Available	1
114	489026-00	HEX NUT	1
115	000000-00	No Longer Available	1
116	902011209232	HEX NUT	2
117	904030301788	LOCKWASHER	2
118	402071115002S	STUD	2
119	402071045007S	SPACER	2
120	1340100	SWITCH COVER ASSY	1
121	901020100567S	MACHINE SCREW	2
122	402040310001S	SWITCH OPENING COVER	1
123	901061203019	SCREW	2
125	904150214138	GARTER SPRING	1
126	904070612942	CUSHION RING	1
127	402051055004	DRIVE SLEEVE	1
128	927012013720	SEGMENT KEY	1

## Parts List for 17-463 Type 2

Item Number	Part Number	Description	Qty Required
129	904150214139	GARTER SPRING	1
130	000000-00	No Longer Available	1
130	000000-00	No Longer Available	1
130	402073775001	QUILL ASSEMBLY	1
131	000000-00	No Longer Available	1
131	5140030-88	SPINDLE	1
132	901030100750	CAP SCREW	1
133	000000-00	No Longer Available	1
134	902070207176S	BEARING CLOSURE NUT	1
135	17-882	17880 W/JACOB MT	1
136	5140043-11	0-1/2 IN 3JAW CHUK	1
137	65-104	KEY	1
138	15-838S	SPANNER WRENCH	1
150	489026-00	HEX NUT	1
151	000000-00	No Longer Available	1
152	000000-00	No Longer Available	1
153	402120685001	KNURLED NUT	1
153	901042601534	THUMB SCREW	1
153	402040885005	MICRO STOP	1
153	402040885005	MICRO STOP	1
153	402040885005	MICRO STOP	1
154	904011031317	SPEC WASHER	1
155	402073885002	STOP ASSY	1
155	402041085007	STOP ROD	1
156	904020201704S	LOCK WASHER	1
157	489191-00	HEX NUT	1
175	000000-00	No Longer Available	1



## Parts List for 17-463 Type 2

Item Number	Part Number	Description	Qty Required
176	901030100750	CAP SCREW	1
177	000000-00	No Longer Available	1
180	902010101300S	HEX NUT	4
181	904010101620S	WASHER	4
182	902030002951	SPEED NUT	4
183	1200037	MOTOR PLATE ASSY	1
184	000000-00	No Longer Available	1
185	904150117105	RING	2
186	901110200834S	CARRIAGE BOLT	4
187	902010201226S	NUT	2
188	904030201674	LOCKWASHER	2
189	426033880001	SET COLLAR ASSY	2
190	491950-00	SET SCREW	2
191	402070715003	PIN	1
192	402070715001	PIN	1
193	902040101403	WING NUT	1
194	1200035	MOTOR PLATE ASSY	1
195	902010101207	HEX NUT	1
196	000000-00	No Longer Available	1
200	000000-00	No Longer Available	1
200	000000-00	No Longer Available	1
201	901010600612S	CAP SCREW	1
202	489026-00	HEX NUT	1
203	901041500206	SET SCREW	1
204	901010600643	CAP SCREW	1
205	901010600637	CAP SCREW	1
206	000000-00	No Longer Available	2

## Parts List for 17-463 Type 2

Item Number	Part Number	Description	Qty Required
207	901041900207S	SET SCREW	1
208	402070205003	CAP	1
209	904070105575	WASHER	1
210	000000-00	No Longer Available	1
211	402070515002	COMPOUND GEAR	1
212	402073145001	TABLE BRACKET	1
212	402070145006	BRACKET	1
213	901041500205	SET SCREW	1
214	902010205438	HEX JAM NUT	1
215	904100313893	WASHER	1
216	402053275002	CLAMP HANDLE	1
217	1641138	KNOB	1
217	1641138	KNOB	1
218	402054065008	WORM SHAFT	1
219	000000-00	No Longer Available	1
220	930059914787	BALL CRANK	1
221	901041500206	SET SCREW	1
225	901010600630	CAP SCREW	1
226	402051055002	SLEEVE	1
227	904010131826	WASHER	1
228	904020201707	LOCK WASHER	1
229	000000-00	No Longer Available	1
230	000000-00	No Longer Available	1
232	000000-00	No Longer Available	1
233	000000-00	No Longer Available	1
234	000000-00	No Longer Available	1
235	000000-00	No Longer Available	1

## Parts List for 17-463 Type 2

Item Number	Part Number	Description	Qty Required
236	904100312097S	SPECIAL WASHER	1
237	000000-00	No Longer Available	1
238	402070055002	BASE	1
239	402070275001	U-BOLT	1
240	904010101618S	STEEL WASHER	2
241	902010101282S	HEX JAM NUT	2