

0 601 657 039
 Issue }
 Stand } 00-05-30

Fig./Abb. 1

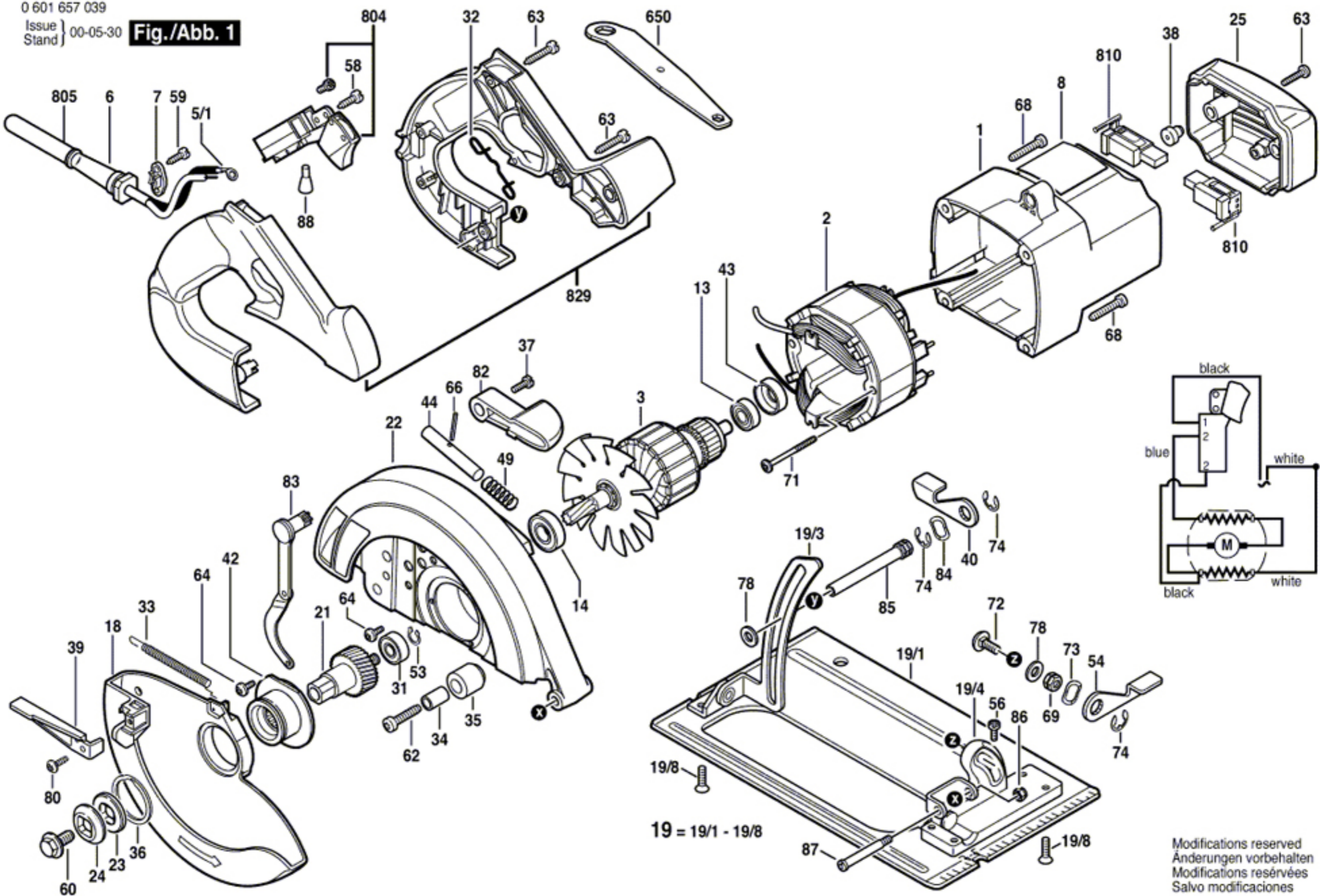

Modifications reserved
 Änderungen vorbehalten
 Modifications réservées
 Salvo modificaciones