

0 601 295 539

Issue } 07-11-08
Stand }

Fig./Abb. 1

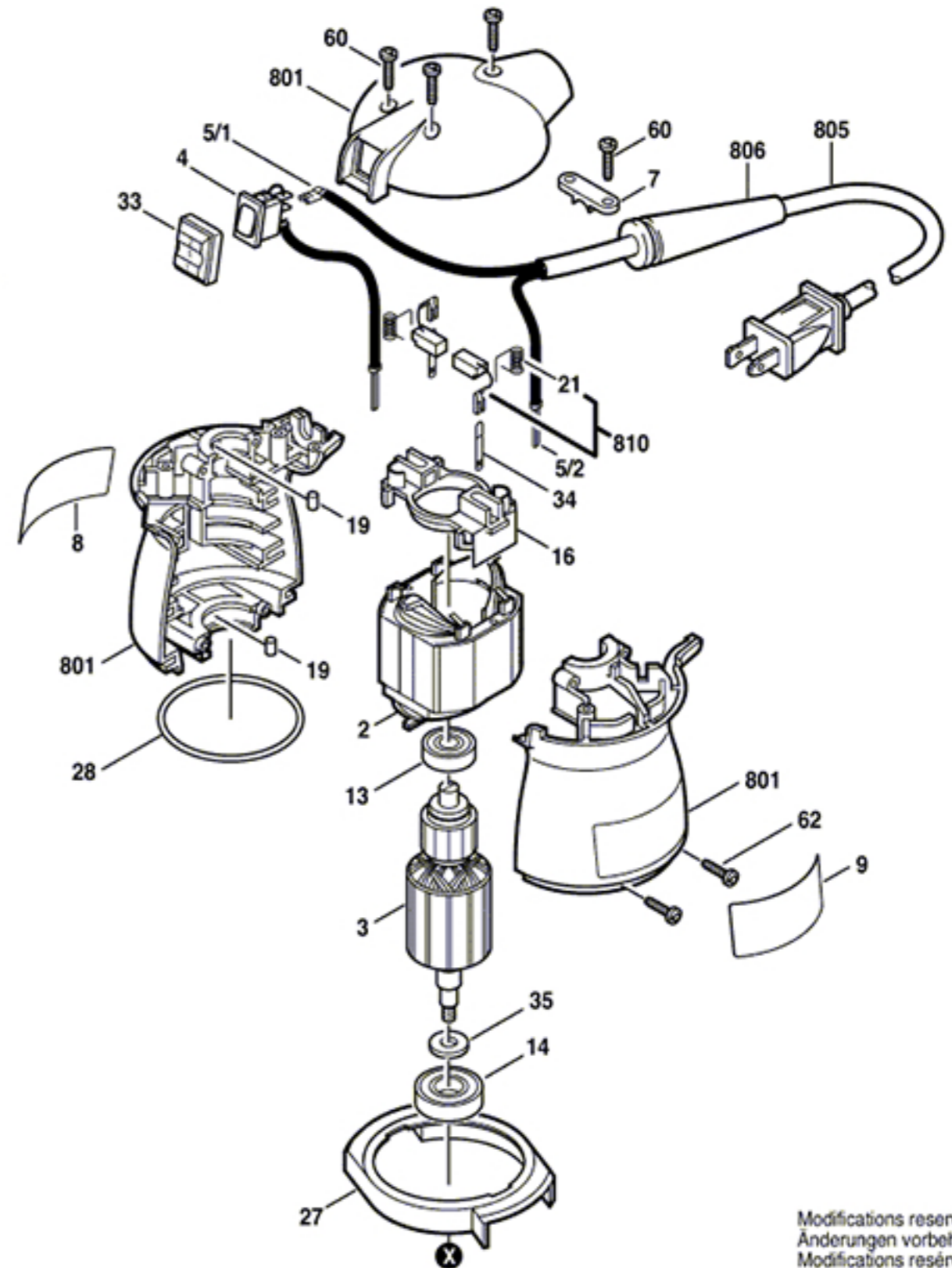
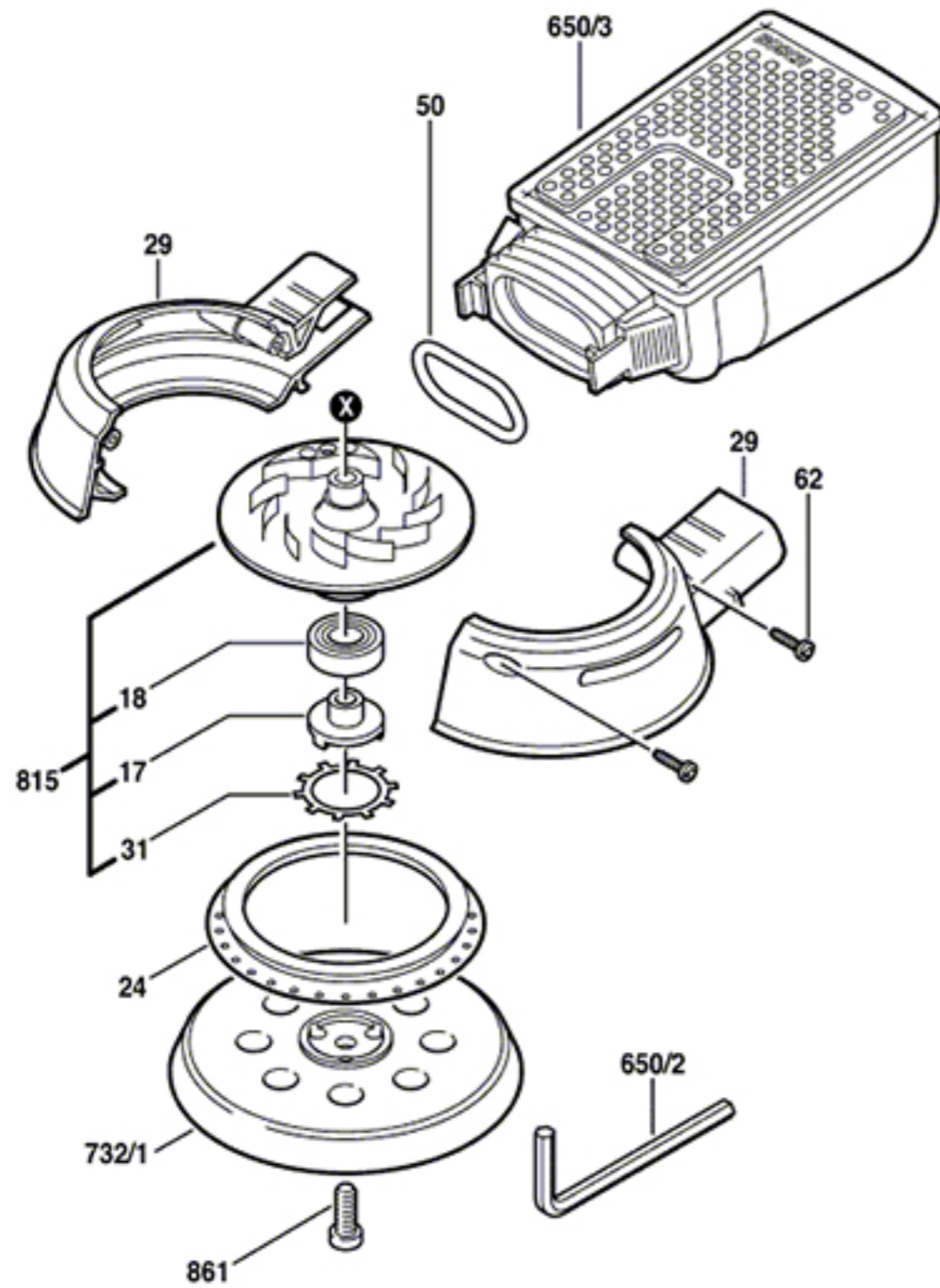

Modifications reserved
Änderungen vorbehalten
Modifications réservées
Salvo modificaciones