

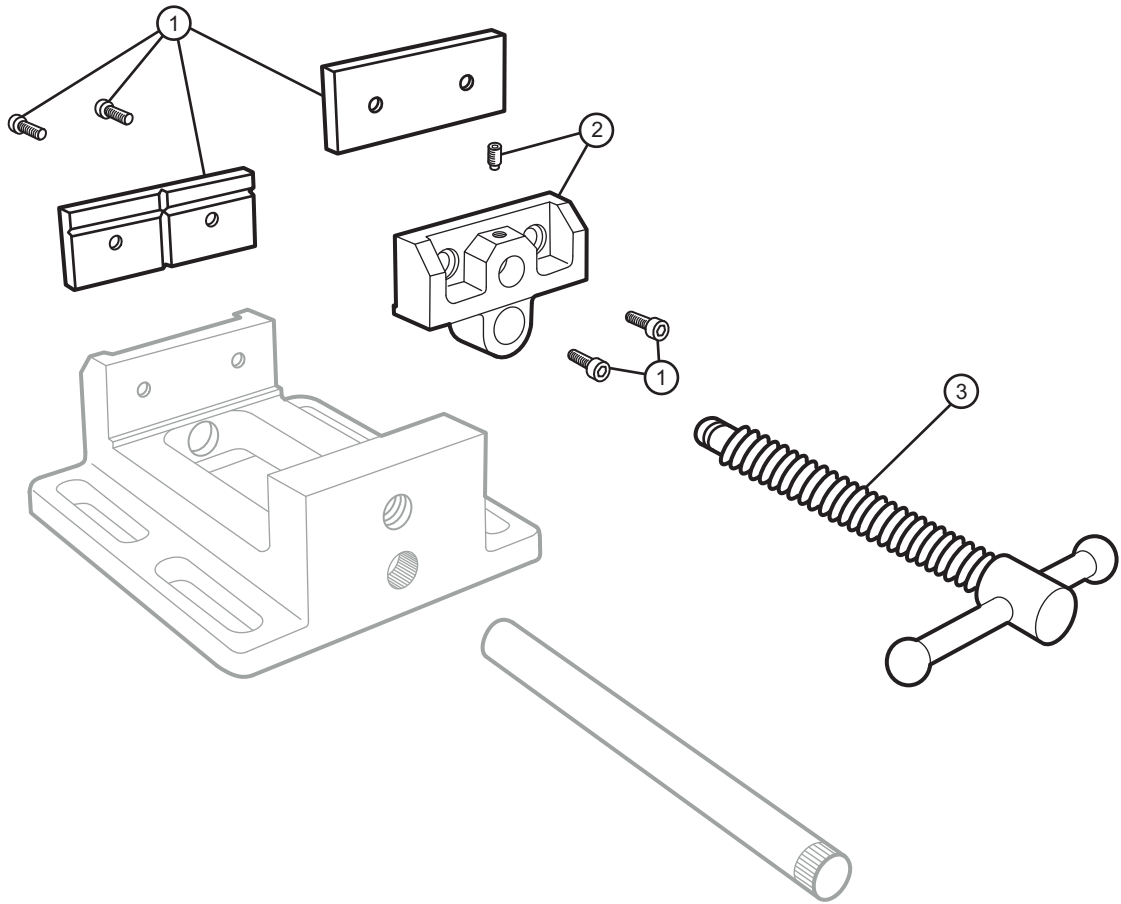

6" Low Profile Drill Press Vise - Parts Diagram

6" Jaw Width, 6" Jaw Opening, 2" Jaw Depth

Stock #: 11746 Model #: LP6



#	Part	Description
1	11746-01	Jaw Insert Assembly (4 screws)
2	11746-02	Movable Jaw & Screw
3	11746-03	Spindle & Handle Assembly