

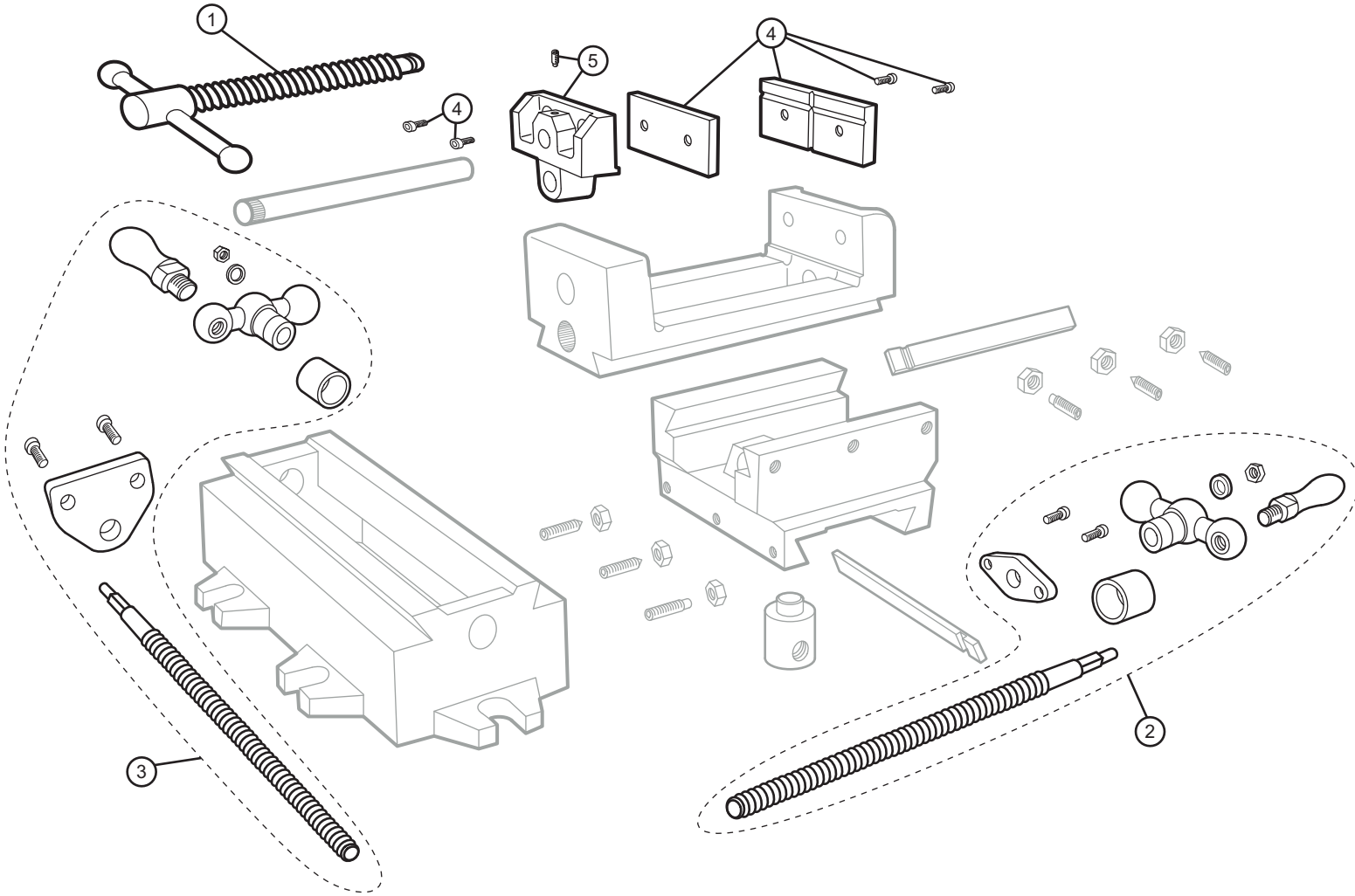

**5" Cross Slide Drill Press Vise - Parts Diagram**

5" Jaw Width, 5" Jaw Opening, 1-1/2" Jaw Depth

Stock #: 11695 Model #: CS5



#	Part	Description
1	11695-01	Handle & Spindle Assembly - 1
2	11695-02	Handle & Spindle Assembly - 2
3	11695-03	Handle & Spindle Assembly - 3
4	11695-04	Jaw Insert Assembly
5	11695-05	Moveable Jaw with Screw