



SERVICE PARTS LIST

BULLETIN NO.
54-42-0490

SPECIFY CATALOG NO. AND SERIAL NO. WHEN ORDERING PARTS			REVISED BULLETIN	DATE
4 V Screwdriver				Mar. 2010
CATALOG NO. 0490-20	STARTING SERIAL NUMBER	B13A	WIRING INSTRUCTION SEE REVERSE	

EXAMPLE:

00	0
----	---

 Component Parts (Small #)
 Are Included When Ordering
 The Assembly (Large #).

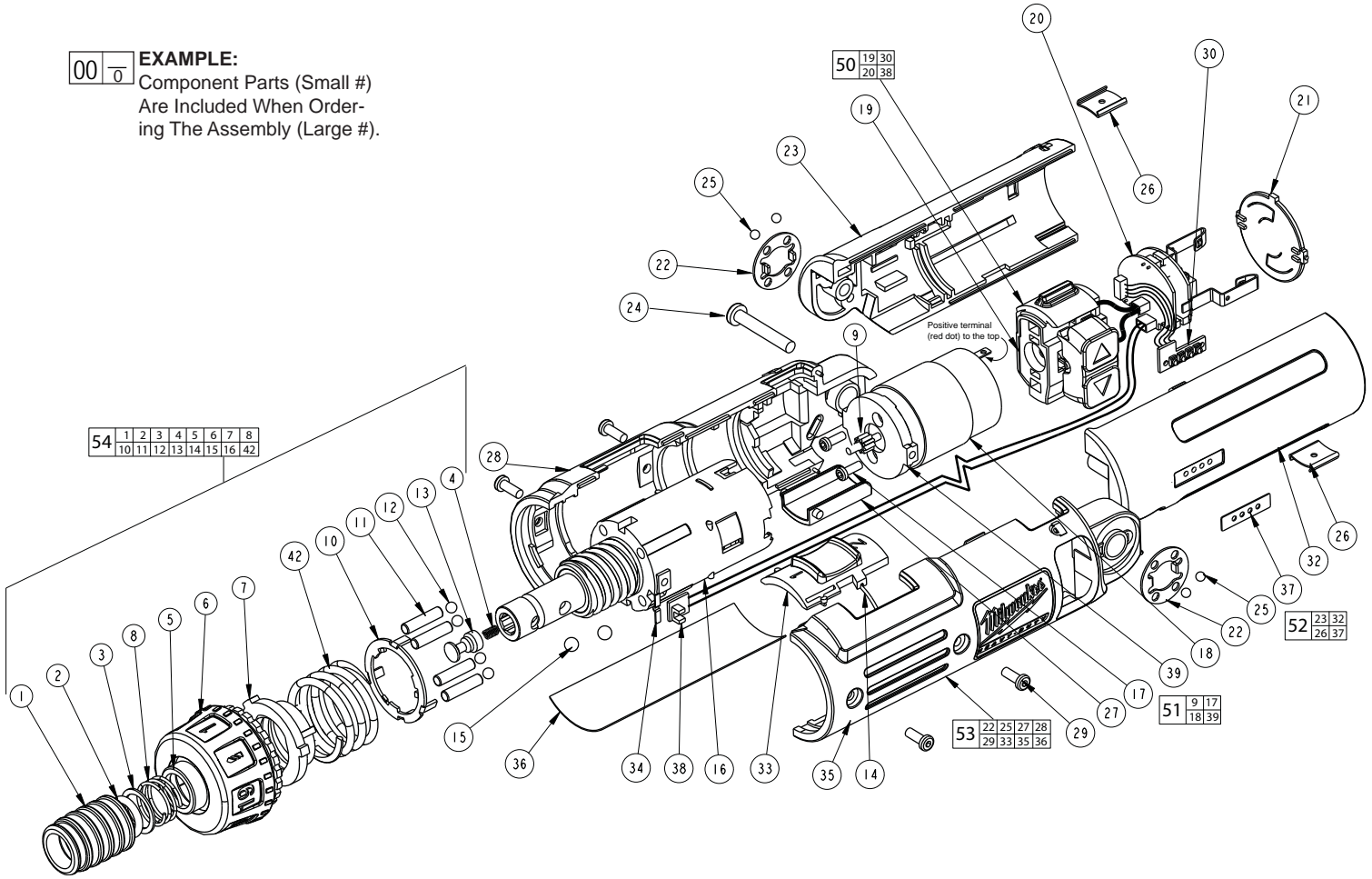
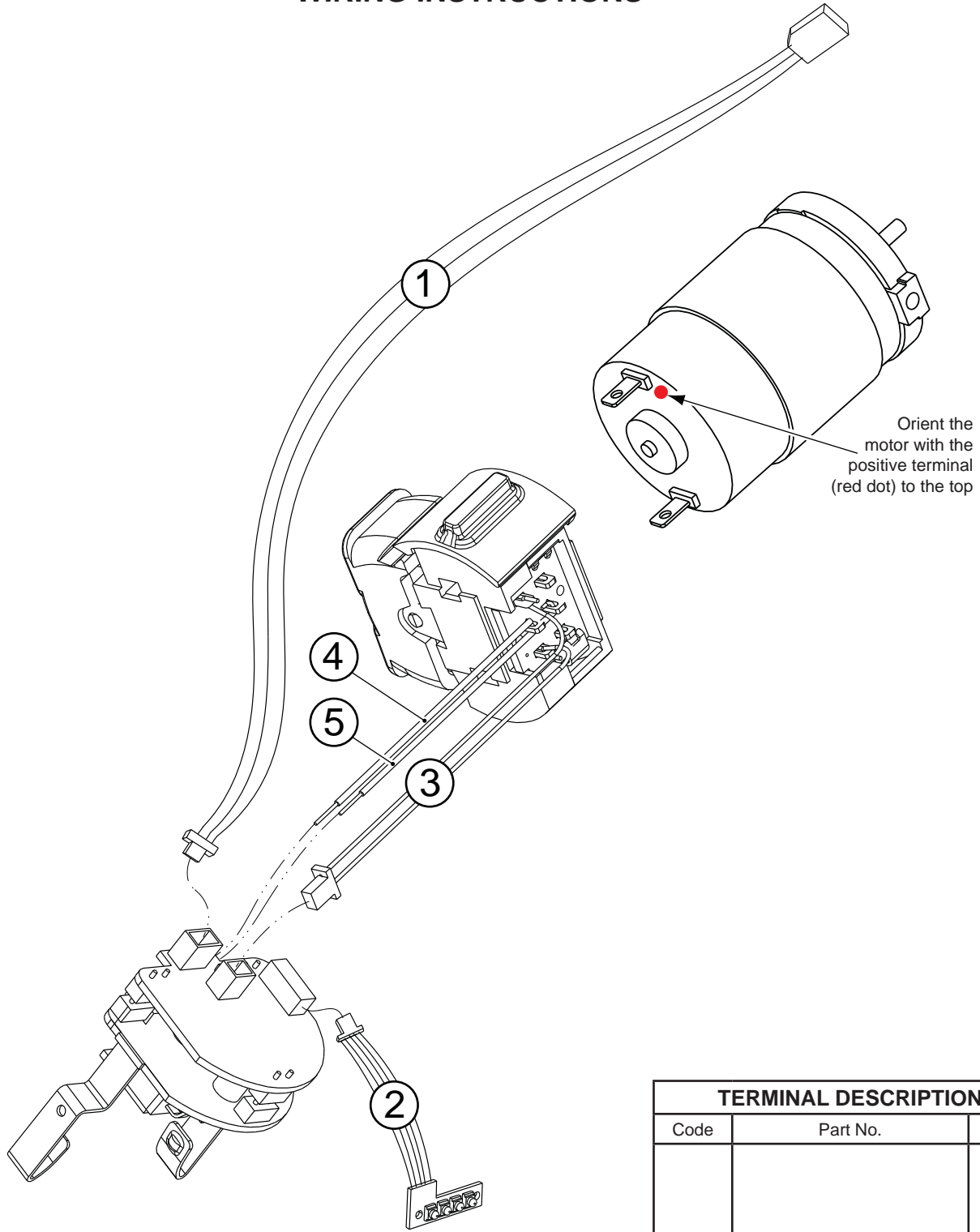

FIG.	PART NO.	DESCRIPTION OF PART	NO. REQ.	FIG.	PART NO.	DESCRIPTION OF PART	NO. REQ.
1	-----	Sleeve	1	24	05-83-0545	Screw	1
2	-----	Seal Ring	1	25	02-02-0165	Ball	4
3	-----	Bit Washer	1	26	40-50-0540	Spring Washer	2
4	-----	Sleeve Spring	1	27	31-15-0225	Hinge Plate	1
5	-----	Press Ring	1	28	-----	Handle Housing Support	1
6	31-58-0085	Clutch Cap	1	29	05-78-0345	Screw	4
7	45-22-0130	Sleeve	1	30	-----	LED	1
8	-----	Spring Chuck	1	32	-----	Handle Housing Cover	1
9	32-60-0255	Pinion Gear	1	33	44-10-0115	Knob (2 speed)	1
10	44-90-0155	Washer Clutch	1	34	40-50-0545	Spring Plate	1
11	44-60-0185	Pin Clutch	4	35	-----	Handle Housing Support	1
12	02-02-0170	Ball	4	36	12-20-0045	Service Nameplate	1
13	-----	Shuttle	1	37	10-20-0655	LED Label	1
14	40-50-0485	Spring Shuttle	1	38	-----	PCB Sensor Cable	1
15	02-02-0175	Ball	2	39	44-66-0145	Motor Mount Plate	1
16	-----	Gearbox Assembly	1	42	40-50-0480	Clutch Spring	1
17	05-82-0255	Screw	2	50	23-66-1075	Switch Assembly Service Kit	1
18	-----	Motor	1	51	14-50-0245	Motor Assembly Service Kit	1
19	-----	Switch Assembly	1	52	31-44-0830	Handle Housing Service Kit	1
20	-----	PCB Assembly	1	53	31-50-0080	Handle Housing Support Service Kit	1
21	31-86-0125	Separator Plate	1	54	14-29-0085	Gear Box Assembly Service Kit	1
22	43-98-0105	Stamping	2				
23	-----	Handle Housing Cover	1				

WIRING INSTRUCTIONS



TERMINAL DESCRIPTION		
Code	Part No.	Qty.

WIRING SPECIFICATIONS				
Wire No.	Wire Color	Origin or Part No.	Length	Terminals, Connectors and End Wire Preparation
1	Multi	23-66-1075	--	PCB Sensor Cable - Component of the Switch Assembly Service Kit
2	Multi	23-66-1075	--	LED Assembly - Component of the Switch Assembly Service Kit
3	Multi	23-66-1075	--	Switch Wire Assembly - Component of the Switch Assembly Service Kit
4	Black	23-66-1075	--	Motor Wire to PCB - Component of the Switch Assembly Service Kit
5	Red	23-66-1075	--	Motor Wire to PCB - Component of the Switch Assembly Service Kit