

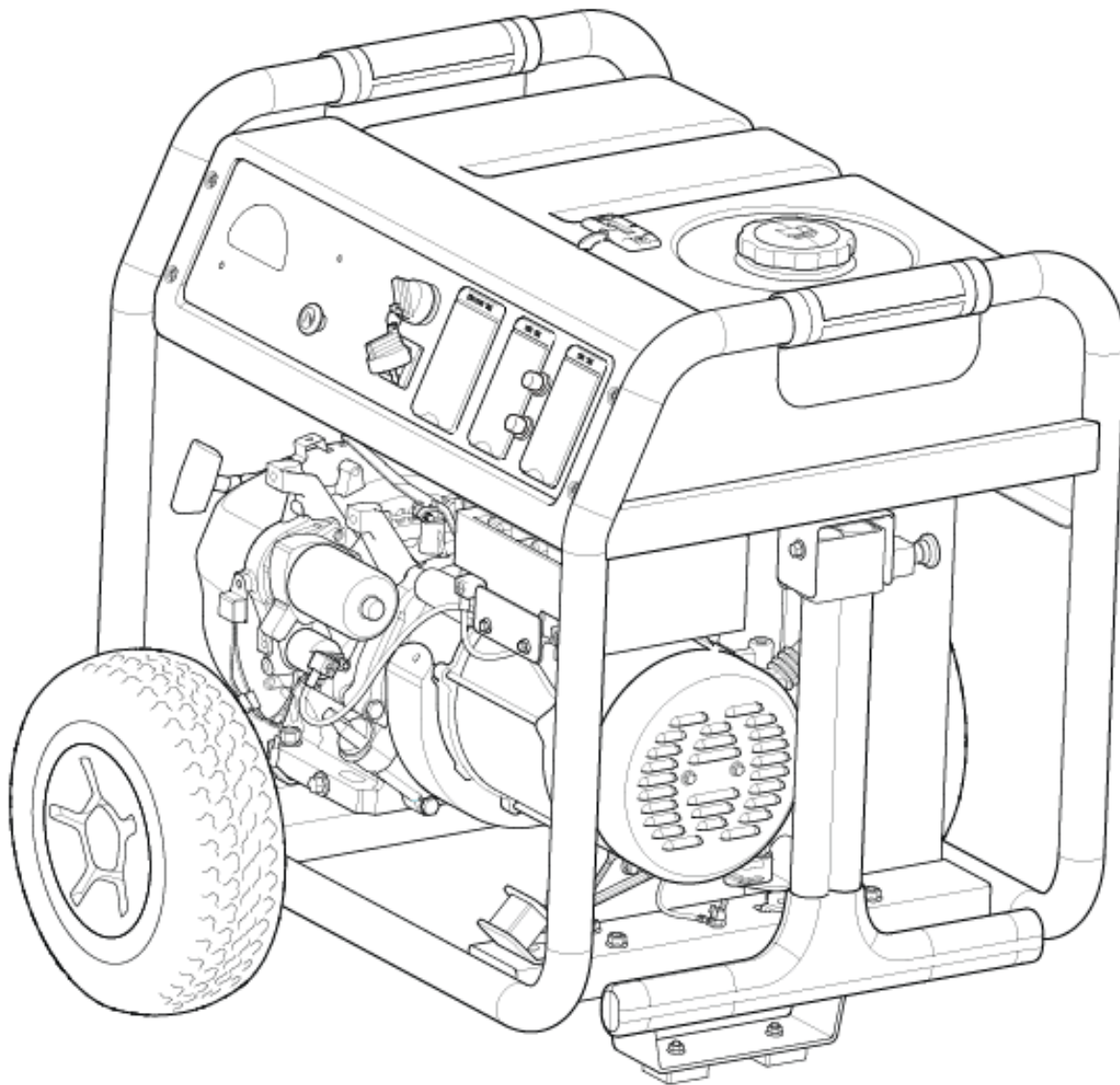

Parts Manual

Mfg. No: 030742-03
8,000 Watt Briggs & Stratton 49 State



Control Panel

Note: Unless noted otherwise, use the standard torque specifications

Mfg. No: 030742-03

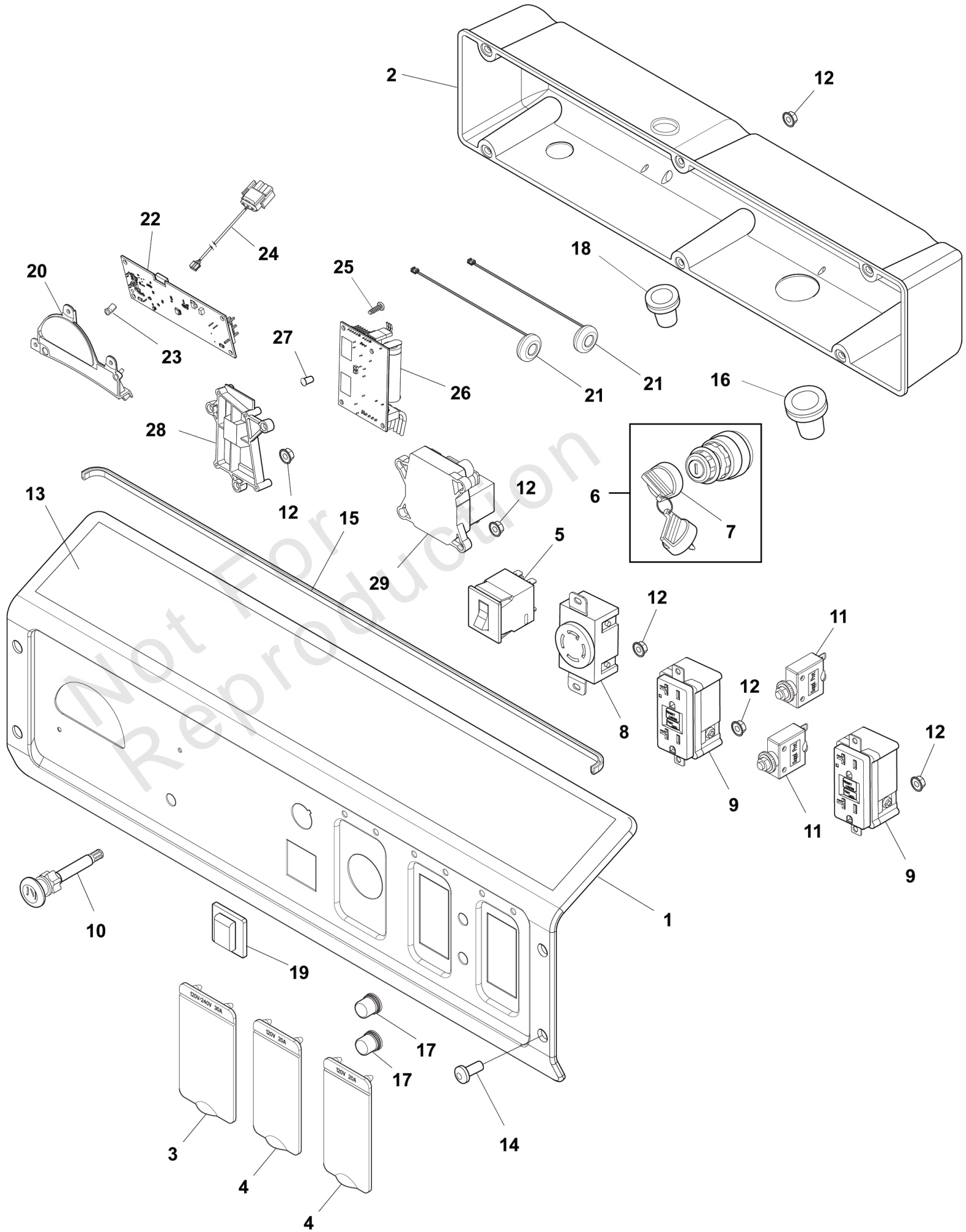

Control Panel

REF NO	PART NO	QTY	DESCRIPTION
1	84002828	1	PANEL-CONTROL
2	84002428	1	BOX- CONTROL PANEL
3	319477GS	1	COVER-OUTLET
4	319476GS	2	COVER-OUTLET
5	84003634	1	BREAKER-Circuit, 30A
6	318307GS	1	KEY-SWITCH IGNITION
7	705436	1	KEY
8	312689GS	1	OUTLET, 120/240V TL30A
9	709526	2	OUTLET-GFCI
10	312034GS	1	CABLE-CHOKE
11	209872GS	2	BREAKER, Circuit, 20A
12	795016	12	NUT
13	84002418	1	DECAL
14	703804	4	SCREW
15	319459GS	1	TRIM-EDGE
16	319529GS	1	GROMMET
17	312636GS	2	BOOT, Circuit Breaker
18	319530GS	1	GROMMET
19	191481GS	1	BOOT, Breaker Circuit
20	705409	1	BRACKET
21	705454	1	TRANSFORMER
22	705408	1	MODULE
23	705780	1	LIGHT
24	706173	1	HARNESS-WIRE
25	84001081	4	SCREW
26	84005244	1	MODULE-CO
27	772217	1	LIGHT-PIPE
28	772213	1	BRACKET-MODULE
29	84002089	1	MODULE-BATTERY CHARGE

Main Unit

Note: Unless noted otherwise, use the standard torque specifications

Mfg. No: 030742-03

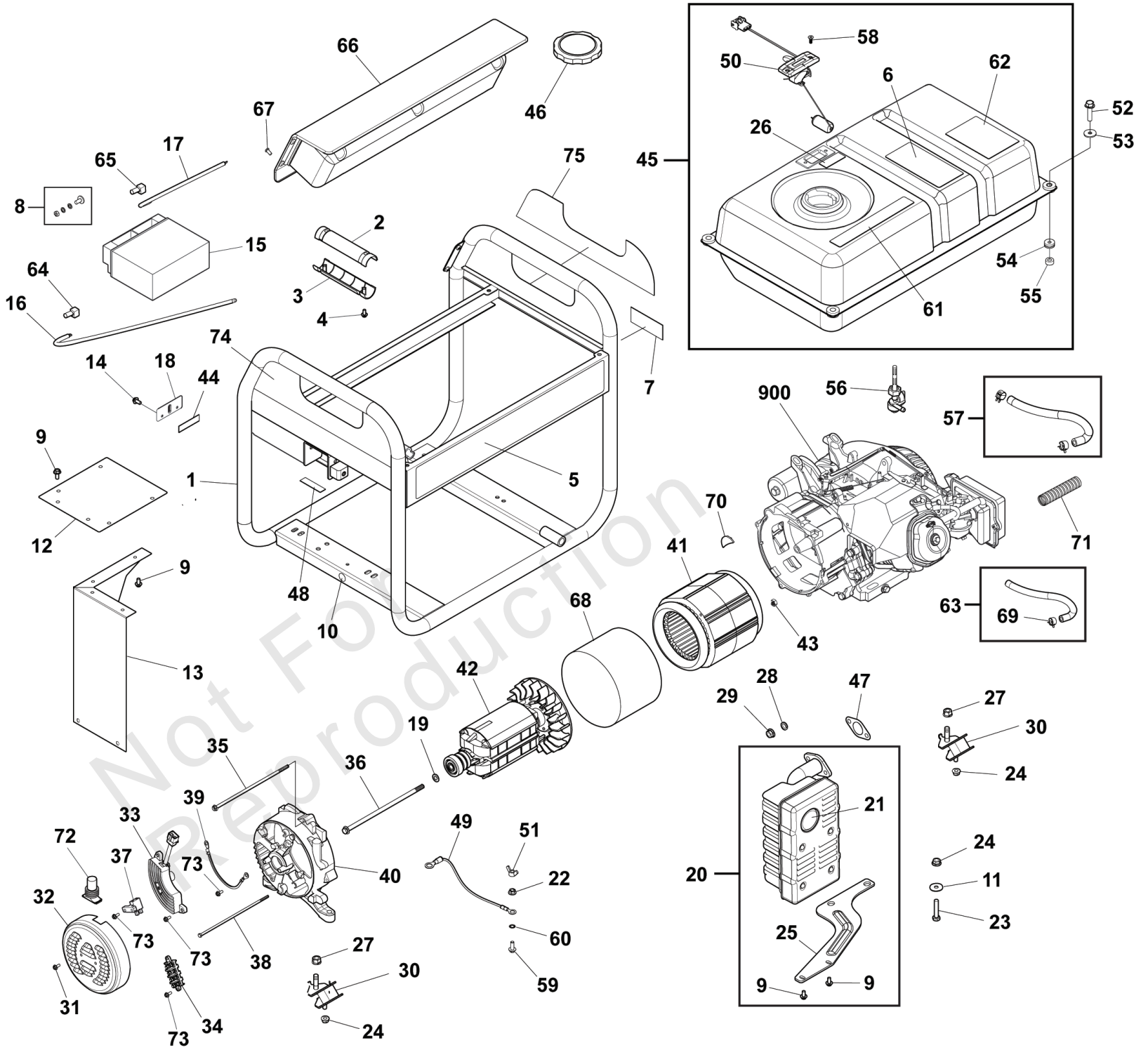

Main Unit

REF NO	PART NO	QTY	DESCRIPTION
1	84002820	1	CRADLE -(Includes Ref. Nos. 5, 7 & 10)
2	312009GS	2	GRIP, Handle
3	312008GS	2	GRIP, Handle
4	75477GS	4	PPHMS, M5 - 0.8 x 20
5	772231	1	DECAL
6	772234	1	DECAL
7	772236	1	DECAL
8	315546GS	1	KIT, Hardware, Battery Terminal
9	706152	14	SCREW, M6 x 12
10	704331	1	DECAL
11	B2495GS	1	WSHR, 25.4 X 8.45 X 1.4
12	312020GS	1	HEATSHIELD
13	312019GS	1	HEATSHIELD
14	209775GS	2	BOLT
15	316345GS	1	BATTERY
16	312014GS	1	CABLE-BATTERY, RED
17	312026GS	1	CABLE-BATTERY, BLACK
18	311983GS	1	PLATE-BATTERY
19	207826GS	1	WASHER, Senci
20	84003865	1	KIT-MUFFLER
21	83083GS	1	SCREEN, Spark Arrest
22	52857GS	1	NUT-M6 FLANGE
23	57821GS	1	CAPSCREW, Hex Head, M8-1.25 x 40
24	67989GS	5	NUT, M8 Flange Serrated
25	84003866	1	BRACKET-MUFFLER
26	705398	1	DECAL
27	52859GS	4	NUT, Lock
28	22237GS	2	WASHER, Locking, 3/8
29	45771GS	2	NUT, M8 - 1.25
30	319451GS	4	MOUNT-VIBRATION
31	700308	2	SCREW
32	312870GS	1	COVER, Rear Bearing
33	701360	1	VOLTAGE REGULATOR
34	312921GS	1	BLOCK, Junction
35	703909	2	BOLT
36	703910	1	BOLT
37	312904GS	1	BRUSH ASSEMBLY
38	703908	2	BOLT
39	706150	1	WIRE
40	312866GS	1	SUPPORT, Bearing
41	701363	1	STATOR
42	701377	1	ROTOR
43	312916GS	4	NUT
44	706377		PAD-RUBBER
45	84002823	1	TANK-FUEL
46	319587GS	1	CAP-FUEL
47	813085GS	1	GASKET
48	706535	1	PAD-RUBBER

Footnotes:

(Note:* Verify your specific engine model, reference the ID Tag located on your engine.) (Refer to your local Briggs & Stratton distributor for parts and service.)

Main Unit

REF NO	PART NO	QTY	DESCRIPTION
49	706165	1	WIRE
50	705407	1	GAUGE-FUEL
51	87680GS	1	NUT, M6 - 1.0 Wing
52	703805	4	SCREW
53	312005GS	4	WASHER
54	189134GS	4	GROMMET, Rubber
55	189137GS	4	SPACER
56	209417GS	1	VALVE, Fuel
57	791745	1	LINE, Fuel
58	314440GS	2	SCREW
59	706166	1	SCREW
60	26850GS	1	WASHER, Ext. M6 - 1/4" Shakeproof
61	772237	1	DECAL
62	84002819	1	DECAL
63	315017GS	1	HOSE, Vapor (cut to fit)
64	319405GS	1	CAP-WIRE, RED
65	319821GS	1	CAP-WIRE, BLACK
66	REF-80080522	1	Refer To Control Panel Group
67	703804	4	SCREW
68	703911	1	BAND-STATOR
69	314955GS	2	CLAMP
70	706376	1	COVER-RUBBER
71	706534	1	BELLOWS
72	207879GS	1	BOOT, Rubber
73	84002093	4	SCREW
74	84002822	1	DECAL
75	84002824	1	DECAL
900	25T235-0348-G1	1	ENGINE

Footnotes:

(Note:* Verify your specific engine model, reference the ID Tag located on your engine.) (Refer to your local Briggs & Stratton distributor for parts and service.)

Wheel Kit

Note: Unless noted otherwise, use the standard torque specifications

Mfg. No: 030742-03

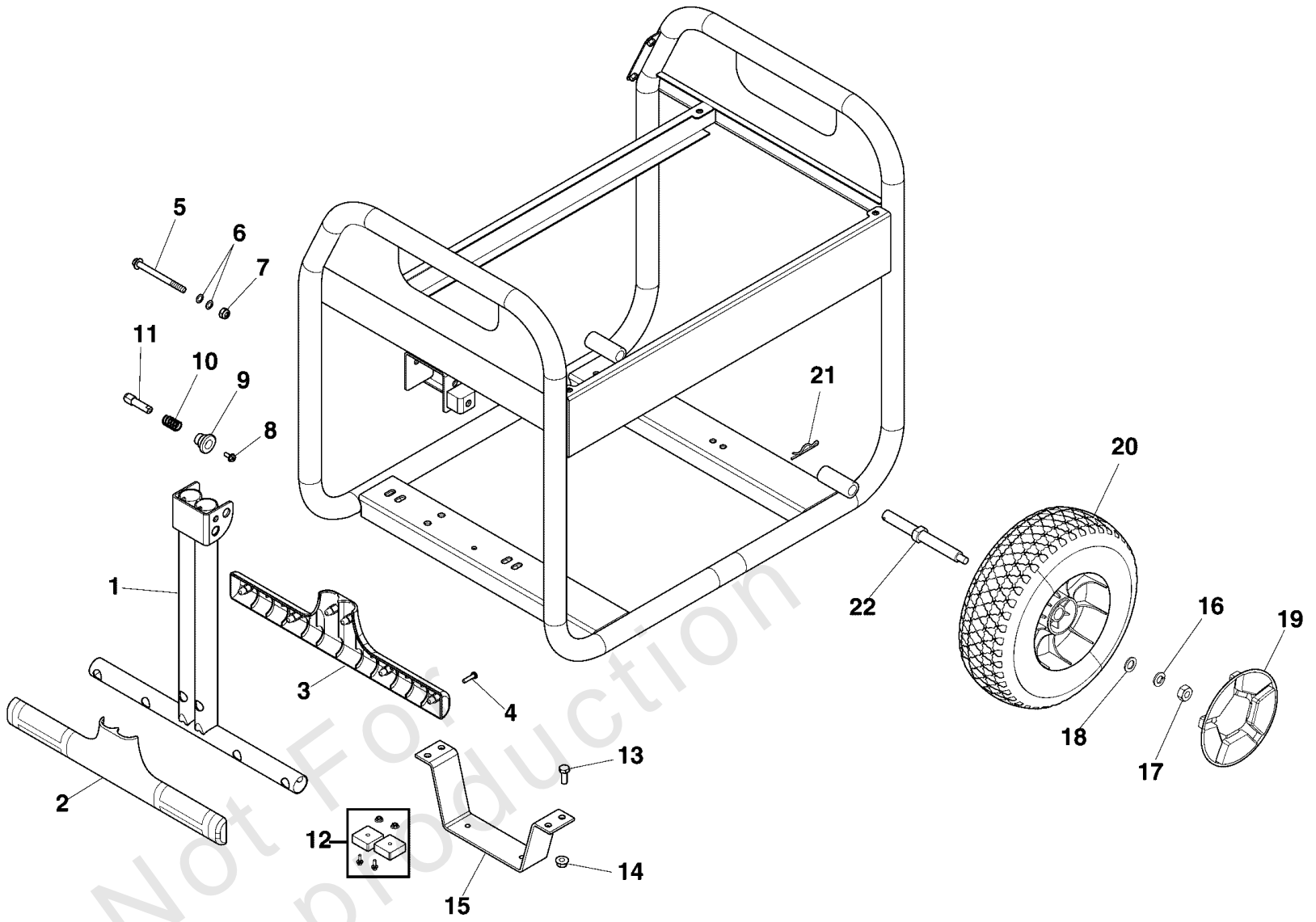

Wheel Kit

REF NO	PART NO	QTY	DESCRIPTION
1	319396GS	1	HANDLE
2	311998GS	1	GRIP-HANDLE
3	312000GS	1	GRIP-HANDLE
4	75477GS	4	PPHMS, M5 - 0.8 x 20
5	318677GS	1	BOLT
6	96716	2	Nylon Step Washer
7	49820GS	1	NUT, Nylok, M8 - 1.25
8	207825GS	1	BOLT-M5-6 x 16
9	319453GS	1	KNOB
10	319452GS	1	SPRING
11	319454GS	1	PIN
12	319285GS	1	MOUNT-VIBRATION
13	67989	4	NUT, M8 Flange Locking Hex M8 - 1.25 Serrated
14	84001684	4	BOLT
15	707688	1	SUPPORT-LEG
16	46526GS	2	WSHR, M10, LOCK
17	45772GS	2	NUT, M10-1.5
18	94856GS	2	WASHER-M10 FLAT
19	312022GS	2	HUBCAP
20	312021GS	2	WHEEL
21	316510GS	2	PIN-HAIR
22	312023GS	2	AXLE

